



ORBITAL CUTTING & BEVELING

Orbital pipe cutting and beveling machines for high-purity process installations





Highlights



GF 8 GF 8 AVM GF 8 MVM



GF 12 GF 12 AVM GF 12 MVM



GF 8, GF 12 (AVM/MVM) | Pipe cutting and beveling machines

The pipe saw for precise cutting in seconds. For more than 40 years installation manufacturers have been relying on the standard formed by Orbitalum in the industrial pipe end preparation: From chemical industry, biotechnology industry, pharmaceutical industry, food processing and beverage industry to energy plant engineering and the shipbuilding.

...More from page 9

BRB 4 Kit 1 boiler pipe processing machine

The solution for tight spaces!
Often only limited space is available for processing between welded boiler pipes. The compact and application-optimized housing design of our BRB machines allows the operator optimized handling in every position and is thus the solution for optimized seam preparation of pipe and pipe sheet connections in boiler and apparatus construction.

Pipe ID/clamping area $\varnothing \Rightarrow$ 19.1 - 47.0 mm (0.752" - 1.850")
Pipe OD \Rightarrow 23.0 - 68.0 mm (0.906" - 2.677")
Wall thickness* min. - max. \Rightarrow 2.0 - 15.0 mm (0.079" - 0.590")

* Depending on material and dimensions. For BRB 4: Aluminum up to 15 mm/0.59" wall thickness. Stainless steel up to 8 mm/0.315" wall thickness. Steel up to 10 mm/0.39" wall thickness.

...More from page 55.



RPG 3.0 (BATTERY) | Tube squaring machine

We are very happy to present the new tube squaring machine RPG 3.0 (battery) for squaring thin-walled stainless-steel pipes.
The RPG 3.0 (battery) completes the RPG series, fitting the dimension range of the OW76S orbital weld head and the GFX 3.0 orbital saw.
The RPG 3.0 (battery) can machine pipes with an outer diameter of 6.0 mm - 77.0 mm and a wall thickness of up to 3.0 mm.
The new RPG 3.0 (battery) produces the best right-angled and burr-free pipe end processing as perfect preparation for orbital welding.

...More from page 45

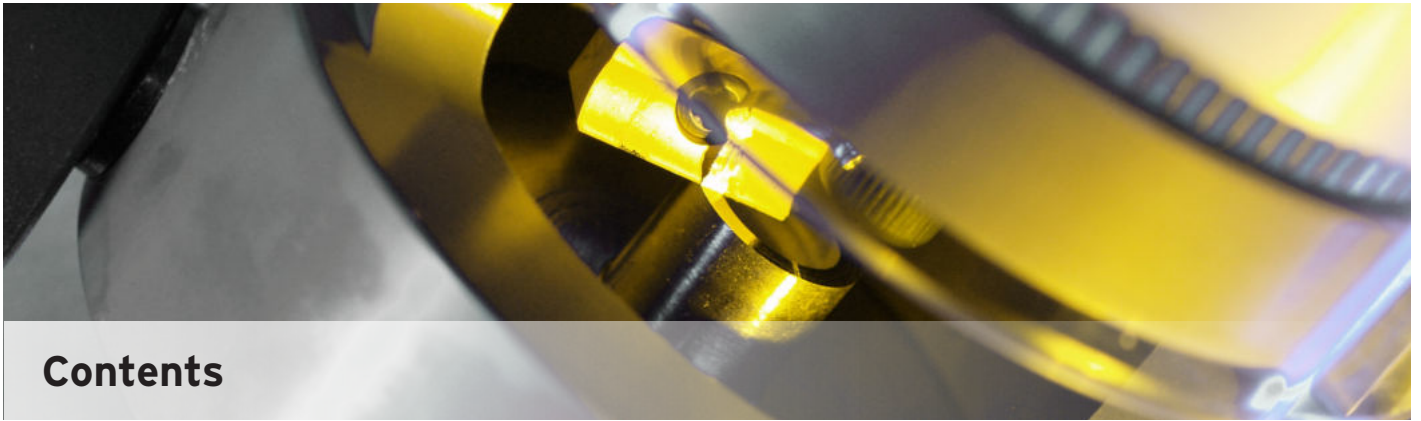

Contents

Highlights	2	Tripod.....	34	Electrode holder	72
Our solutions	4	MRA		Wall, table vice mount	72
At a glance	5	Metal pipe cutter	35	Dust protection	72
Markets and applications	6	MRA cutting chains.....	36	Double-decker kit	72
PIPE CUTTING AND BEVELING TECHNOLOGY	7	MRA collars.....	36	THREAD-CUTTING AND THREAD SEALING TECHNOLOGY	73
GF 4, GF 6 (AVM/MVM)		TUBE SQUARING TECHNOLOGY	37	Accessories for thread-cutting technology	74
Pipe cutting and beveling machines	9	RPG ONE, RPG 1.5		Replacement thread-cutting jaws for ASK cutting heads	74
GF 8, GF 12 (AVM/MVM)		Tube squaring machines (electric/battery)	39	Nipple retainer	74
Pipe cutting and beveling machines	13	Angle drive for RPG ONE (battery) and RPG 1.5 (battery).....	41	Thread sealant	75
GFX 3.0, GFX 6.6		Special-steel clamping collars.....	42	Flax dispenser "10-unit sales display package".....	75
Pipe cutting and beveling machines	17	Tool holder WH.....	44	Seals	76
Hard-sided transport case.....	19	Multifunctional tool MFW	44	Seal dispenser	76
Accessories for GF machines	21	RPG 3.0 (battery), RPG 4.5 (S), RPG 8.6		Seals.....	76
Saw blade lubricant GF TOP.....	22	Tube squaring machines	45	COPPER PIPE INSTALLATION TECHNOLOGY	77
Saw blade lubricating paste GF LUB.....	22	Clamping collars.....	48	Accessories for LAM 1500, LAM 1600	78
Special gear oil.....	22	Tool holder WH.....	50	Rod electrodes	78
Replacement cable with rotary contact.....	23	Multifunctional tool MFW	50	ACCESSORIES FOR WORKSHOP AND CONSTRUCTION SITE	79
Quick-mounting plates with screw clamps	23	PIPE BEVELING TECHNOLOGY	51	Folding workbench, pipe deburring device	80
Mobile workstation.....	23	The right tool for your individual requirement	52	Folding workbench	80
Pipe feeder basic unit and extension unit	24	BRB 4		Pipe deburring device.....	80
Saw blades and bevel cutters for GF and GX machines	26	Boiler pipe preparation machines	53	ESG Plus, ESG Plus²	
Saw blades and bevel cutters for GF machines.....	27	REB 6		Electrode grinders	69
Saw blade bevel cutter combinations.....	28	Pipe end processing machine	57	Diamond grinding wheels.....	71
Weld seam saw blade bevel cutter combinations (V-seam).....	28	Accessories for BRB and REB machines	60	Cutting devices.....	71
Individual parts to weld seam saw blade bevel cutter combinations (V-seam).....	28	Tool holder WH.....	60		
Supporting ring for saw blade bevel cutter combinations.....	28	Multifunctional tools MFW "Economy"	61		
Press fitting saw blade bevel cutter combinations	28	Multifunctional tools MFW "High-Performance"	61		
Individual parts for press fitting saw blade bevel cutter combinations.....	29	Feed ratchet for BRB 4.....	62		
Chamfer cutter	29	Balancer spring	62		
Chamfer cutter V-seam.....	29	Cooling cutting material KSS-TOP.....	62		
Saw blade lubricant GF TOP	29	Tube elbow tensioner.....	62		
Saw blade lubricating paste GF LUB.....	29	Clamping wedge sets optional.....	62		
Saw blades for SCORP machines	30	Combination possibilities of tool holders WH and multifunctional tool MFW for REB and BRB machines	63		
TCT saw blade	30	ELECTRODE PROCESSING TECHNOLOGY	67		
Diamond cutting blade	30	ESG Plus, ESG Plus²			
Cermet saw blade	30	Electrode grinders	69		
PS 4.5 Plus		Diamond grinding wheels.....	71		
Portable pipe saw	31	Cutting devices.....	71		
Quick-mounting plate with screw clamps	33				
Saw blades.....	33				



Our solutions

Our products offer a wide application range. Whether you want to machine large, small, thin-walled or thick-walled, high-alloyed or low-alloyed pipes; we definitely have the right solution. This quick reference shows the wide range of application possibilities of our machines.

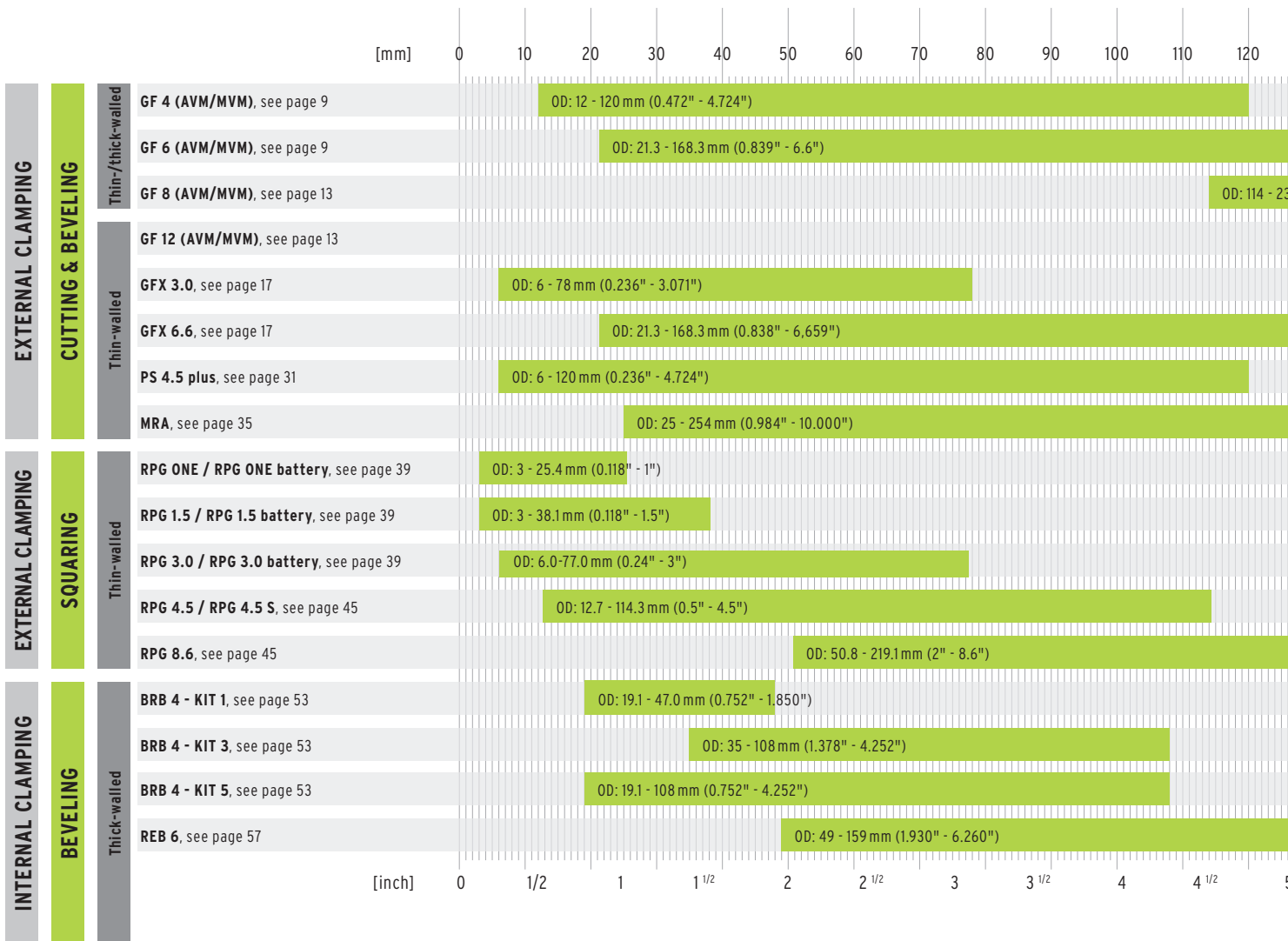



At a glance

Interested in a personal consultation?

Then contact us under +49 (0) 77 31 792-0 or send an email to tools@orbitalum.com. Our team is happy to find a suitable product for your individual requirements.

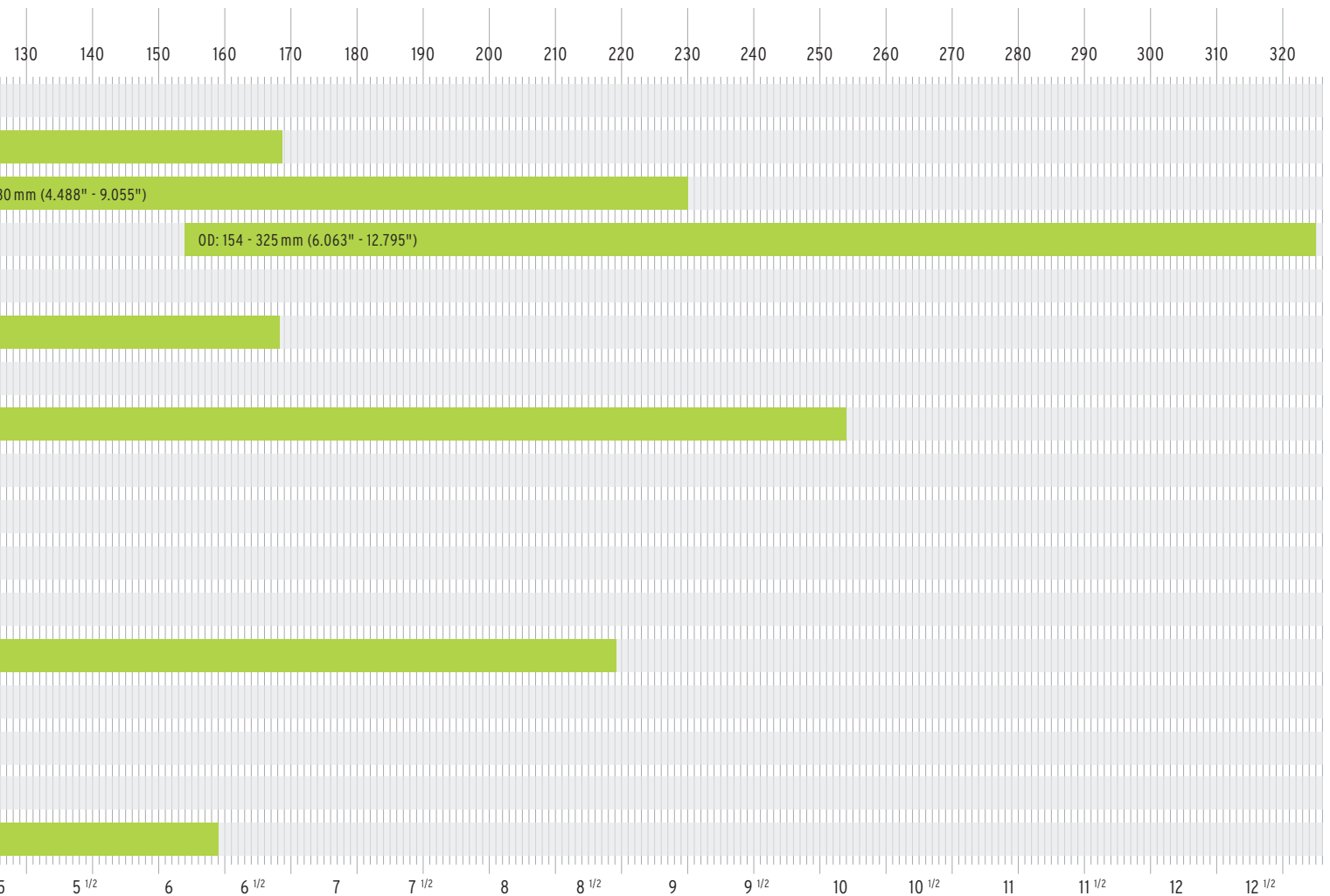



Markets and applications

Orbitalum is a global leader for portable, powerful pipe cutting, squaring and beveling machines for industrial weld seam preparation. In addition Orbitalum offers a wide range of orbital welding systems for high-purity, process as well as heat exchanger applications. Orbitalum products have a wide range of applications in the following fields:

Application	e.g.	Products
Boilers & heat exchangers	<ul style="list-style-type: none"> • Pipe bundle heat exchangers • Box headers • Boilers • HVAC blade heat exchangers 	<ul style="list-style-type: none"> • RPG tube squaring machines • BRB boiler pipe preparation machines • ORBIMAT welding power sources • ORBIWELD weld heads • P16, P20 pipe-in-sheet weld heads • HX weld heads • TX weld heads • ORBmax residual oxygen meter
Pharmaceuticals & chemical industry	<ul style="list-style-type: none"> • HP High-Purity • Process lines • Mixing valves • CIP "Cleaning in Place" lines 	<ul style="list-style-type: none"> • GF, PS & GFX pipe cutting and beveling machines • RPG tube squaring machines • ORBIMAT welding power sources • ORBIWELD weld heads • ORBmax residual oxygen meter
Semi-conductor	<ul style="list-style-type: none"> • HP High-Purity • UHP Ultra High-Purity • Process lines • Gas cabinets • Component production • CFOS gas supply • PCW cooling water supply 	<ul style="list-style-type: none"> • RPG tube squaring machines • ORBIMAT welding power sources • ORBIWELD weld heads • ORBmax residual oxygen meter
Aerospace technology	<ul style="list-style-type: none"> • Hydraulic • Fuel supply • Engine components • Air conditioning 	<ul style="list-style-type: none"> • GF, PS & GFX pipe cutting and beveling machines • RPG tube squaring machines • ORBIMAT welding power sources • ORBIWELD weld heads • ORBmax residual oxygen meter
Food processing, dairy and beverage industries	<ul style="list-style-type: none"> • HP High-Purity • Process lines • Mixing valves • CIP "Cleaning in Place" lines 	<ul style="list-style-type: none"> • GF, PS & GFX pipe cutting and beveling machines • RPG tube squaring machines • ORBIMAT welding power sources • ORBIWELD weld heads • ORBmax residual oxygen meter

Pipe cutting and beveling technology



Quality products from Orbitalum Tools - always a good decision!

 Quality
made in
Germany

For our products we select the best materials and suitable production processes and already during development place particular on a high degree of quality and durability.

Our machines and tools are assembled, set, controlled and packed by hand by qualified and motivated employees with great care in Singen/Htwl. (Germany).

Our employees guarantee this with their knowledge and their experience.

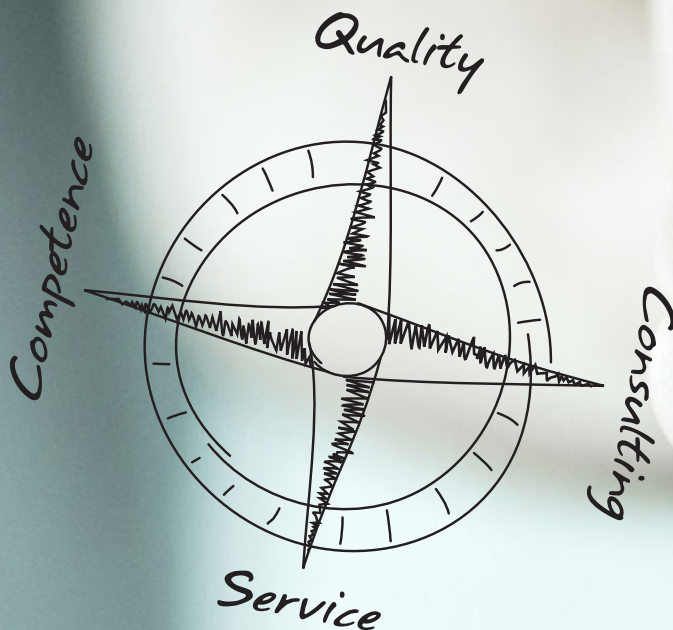

GF 4, GF 6 (AVM/MVM)

Pipe cutting and beveling machines

The pipe saw for precise cutting in seconds. For more than 40 years installation manufacturers have been relying on the standard formed by Orbitalum in the industrial pipe end preparation: From chemical industry, biotechnology industry, pharmaceutical industry, food processing and beverage industry to energy plant engineering and the shipbuilding.

The GF series sets standards in orbital pipe processing! Numerous innovative functions combined with an ergonomic design give you considerable advantages in industrial preproduction of pipeline systems



Right-angled, burr-free and cold processing process	✓
Deformation-free clamping system for thin-walled and thick-walled pipes	✓
Optimum preparation for the automated welding process	✓
Robust design with powerful drive	✓
Unique, automatically guided immersion process	✓
Beveling of pipe ends during the cutting process or separately	✓
High cost effectiveness, increased productivity	✓
Long tool service lives	✓
Anthracite, coated parts offer better slide characteristics and corrosion protection	✓

Prerequisite for productive and high quality welding of pipes with automated orbital joining technology is a precise, right-angled and burr-free cut as well as perfect beveling of the pipe end. Easy to handle and precise cutting in seconds, the GF series machines pipe materials made of high-alloyed steel (stainless steel), low-alloyed and unalloyed steel, cast materials, plastics and non-ferrous metals according to the procedure of "planetary cutting". In the process the powerful clamping is carried out without any deformation of the workpiece.

Optionally the user, apart from pure manual actuation, has the choice between a manual (MVM) and an automatic (AVM) feeding module. The latter optimizes the cutting result, increases the service life of the tools, and reduces physical strain for the operator. The result: maximum reliability and productivity.

ADDITIONAL ADVANTAGES:

- Set of stainless steel caps to avoid contact corrosion included
- Optionally with feeding module AVM or MVM for automatic or mechanized separation cut, thus lower physical strain for the operator.
- Locking of the rotary movement protects against unauthorized use and theft
- Ergonomically optimized motor handle allows improved operator position as well as cutting of tube elbows without conversion
- Integrated line laser to mark the cut-off point
- Clamping jaws for changing to cut short hose pieces and for vibration-free cutting of smaller pipe dimensions (only for GF 4)
- Multifunctional keys for all settings at the machine
- Optimized speed control (40-215 rpm), ideal for cutting high-performance materials (Hastelloy®, P91, etc.)

- Plug connection with a quick-disconnect coupler: easy and quick replacement of the power cable
- Optimized chips guard protects against chips flying off; chips guard for GF 4 with opening for folding rule to measure the pipe length

FEED VARIANTS:

Pipe cutting and beveling machine with **automated feeding module AVM***: The intelligent control of the AVM continuously monitors the feed force as a function of the required output. After completion of the cutting process the AVM switches off automatically. An inadvertent startup is prevented by a restart inhibitor. Pipe cutting and beveling machines **with manual feeding module MVM***: An add-on module at the machine makes it easier to machine pipes through a manually operated handwheel. This ensures that the machine head rotates easily around the pipe user-friendly with little effort and constant feed.

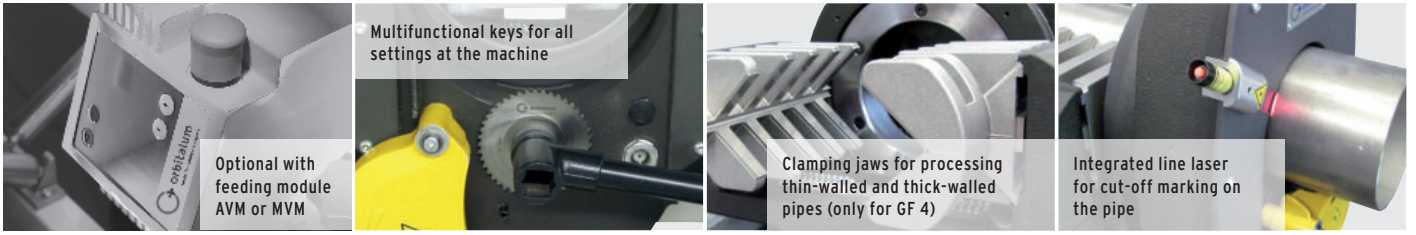

APPLICATION AREA		GF 4	GF 4 AVM*	GF 4 MVM*	GF 6	GF 6 AVM*	GF 6 MVM*
Code	[230 V] [120 V]	790 142 001 790 142 002	790 142 011 790 142 012	790 142 021 790 142 022	790 143 001 790 143 002	790 143 011 790 143 012	790 143 021 790 143 022
Pipe OD	[mm] [inch]	12 - 120 0,472 - 4,724	12 - 120 0,472 - 4,724	12 - 120 0,472 - 4,724	21.3 - 168.3 0,839 - 6,626	21.3 - 168.3 0,839 - 6,626	21.3 - 168.3 0,839 - 6,626
Wall-thickness depending on material	[mm] [inch]	1 - 9 0,039 - 0,354	1 - 9 0,039 - 0,354	1 - 9 0,039 - 0,354	1.5 - 15 0,059 - 0,591	1.5 - 15 0,059 - 0,591	1.5 - 15 0,059 - 0,591
Pipe ID min. (saw blade Ø 63 mm)	[mm]	21	21	21	30	30	30
Pipe ID min. (saw blade Ø 2.480")	[inch]	0.827	0.827	0.827	1.181	1.181	1.181
Pipe ID min. (saw blade Ø 68 mm)	[mm]	16	16	16	25	25	25
Pipe ID min. (saw blade Ø 2.677")	[inch]	0.630	0.630	0.630	0.984	0.984	0.984
Pipe ID min. (saw blade Ø 80 mm)	[mm]	4	4	4	13	13	13
Pipe ID min. (saw blade Ø 3.150")	[inch]	0.157	0.157	0.157	0.512	0.512	0.512
Pipe ID min. (saw blade Ø 100 mm)	[mm]	-	-	-	0	0	0
Pipe ID min. (saw blade Ø 3.937")	[inch]	-	-	-	0	0	0
Materials		Special steel (any Cr- and Mo-content); special steel stainless (any Cr- and Mo-content); special steel (Cr < 12% and Mo < 2.5%; Cr < 20% and Mo = 0%); Case hardening steels, high-speed steels, heat-treated steels, rolling bearing steels, tool steels; black and galvanized steel pipe; general structural steel; annealed cast pipe (GGG); aluminum; brass; copper; plastic (PE, PP, PVDE, PVC)					
TECHNICAL SPECIFICATIONS		GF 4	GF 4 AVM*	GF 4 MVM*	GF 6	GF 6 AVM*	GF 6 MVM*
Power	[kW] [hp]	1.8 2.41	1.9 2.54	1.8 2.41	1.8 2.41	1.9 2.54	1.8 2.41
Power AVM	[kW] [hp]	-	0.05 0.07	-	-	0.05 0.07	-
Built-in electronic speed regulation with speed stabilization	[rpm]	40 - 215	40 - 215	40 - 215	40 - 215	40 - 215	40 - 215
Rotary speed machine head with AVM	[rpm]	-	0.1 - 3.9	-	-	0.3 - 3.5	-
Torque machine head max. with AVM	[Nm]	-	101	-	-	353	-
Protection class	[Class]	II (DIN EN 60745-1)	I (DIN EN 60204-1)	II (DIN EN 60745-1)	II (DIN EN 60745-1)	I (DIN EN 60204-1)	II (DIN EN 60745-1)
Sound pressure level at the workplace approx.	[dB (A)]	79	79	79	79	79	79
Vibration level (according to DIN EN 28662, Part 1)	[m/s ²]	< 2.5	< 2.5	< 2.5	< 2.5	< 2.5	< 2.5
Mains fuse on site	[A]	16	16	16	16	16	16
Dimensions (LxDxH)	[mm] [inch]	480 x 325 x 680 18.9 x 12.8 x 26.8	480 x 325 x 810 18.9 x 12.8 x 31.9	480 x 325 x 780 18.9 x 12.8 x 30.7	574 x 352.7 x 920 22.6 x 13.9 x 36.2	574 x 352.7 x 972 22.6 x 13.9 x 38.3	574 x 352.7 x 920 22.6 x 13.9 x 36.2
Machine weight approx.**	[kg] [lbs]	55.0 121.2	64.5 142.2	60.0 132.2	92.7 204.4	101.7 224.2	97.8 215.6
Versions (single-phase alternating current)	[V, Hz]	230 V, 50/60 Hz 120 V, 50/60 Hz	230 V, 50/60 Hz 120 V, 50/60 Hz	230 V, 50/60 Hz 120 V, 50/60 Hz	230 V, 50/60 Hz 120 V, 50/60 Hz	230 V, 50/60 Hz 120 V, 50/60 Hz	230 V, 50/60 Hz 120 V, 50/60 Hz
SCOPE OF DELIVERY		GF 4	GF 4 AVM*	GF 4 MVM*	GF 6	GF 6 AVM*	GF 6 MVM*
Pipe cutting and beveling machine	PCS.	1	1	1	1	1	1
Transportation case	PCS.	1	1	1	1	1	1
Set of stainless steel caps	PCS.	1	1	1	1	1	1
Saw blade (Code 790 ...)	PCS.	1 (...042 064)	1 (...042 064)	1 (...042 064)	1 (...043 018)	1 (...043 018)	1 (...043 018)
Mounting plate	PCS.	1	1	1	1	1	1
Line laser with fastening screws and 10 button cells 1.5 V (Code 790 142 124)***	PCS.	1	1	1	1	1	1
Tool key set with accessories	Set	1	1	1	1	1	1
Special gear oil (Code 790 041 030)	Bottle	1	1	1	1	1	1
Operating instructions and spare part list	Set	1	1	1	1	1	1

Technical specifications are non-binding. They do not constitute any assurance of properties. We reserve the right to make changes.

- * The automatic or manual feeding module AVM/MVM is already mounted on the pipe saw on delivery.
- ** Weight without packaging and accessories.
- *** The line laser is supplied separately at the GF 6 (AVM/MVM) and has to be mounted on the machine before commissioning.



Pipe cutting and beveling machines

GF 4, GF 6 (AVM/MVM)

Properties, application area, technical specifications and delivery scope, see from pPage 99.

ITEM	VERSION	CODE	MACHINE WEIGHT KG	SHIPPING WEIGHT KG
GF 4	230 V, 50/60 Hz EU	790 142 001	61.300	88.000
GF 4	120 V, 50/60 Hz EU/US	790 142 002	61.300	88.000
GF 4 AVM	230 V, 50/60 Hz EU	790 142 011	70.500	98.000
GF 4 AVM	120 V, 50/60 Hz EU/US	790 142 012	70.500	98.000
GF 4 MVM	230 V, 50/60 Hz EU	790 142 021	66.600	98.000
GF 4 MVM	120 V, 50/60 Hz EU/US	790 142 022	66.600	98.000
GF 6	230 V, 50/60 Hz EU	790 143 001	92.700	140.000
GF 6	120 V, 50/60 Hz EU/US	790 143 002	92.700	140.000
GF 6 AVM	230 V, 50/60 Hz EU	790 143 011	101.700	153.000
GF 6 AVM	120 V, 50/60 Hz EU/US	790 143 012	101.700	153.000
GF 6 MVM	230 V, 50/60 Hz EU	790 143 021	97.800	147.000
GF 6 MVM	120 V, 50/60 Hz EU/US	790 143 022	97.800	147.000

Suitable accessories:

- Saw blades and bevel cutters, see from page 26
- High quality lubricants for sawing and milling, see page 22
- Special gear oil, see page 22
- Replacement cable with rotary contact, see page 23
- Quick-mounting plates with screw clamps, see page 23
- Mobile workstation, see page 23
- Pipe feed basic unit and extension unit, see from page 24
- Folding workbench, see page 80



GF 4, GF 6



GF 4 AVM, GF 6 AVM



GF 4 MVM, GF 6 MVM

Just rent and stay flexible.

We offer rental machines for short-term and long-term rental - as a cost-effective alternative to purchasing.

Our rental machines are serviced regularly and are thus always in top condition. We are happy to help to find suitable machines for your individual application. By the way renting is an excellent opportunity to test a machine before you buy it.

Advantages of renting:

- Lower storage costs
- No repair costs
- Small investment
- Always the newest technology in use
- Minimum downtimes

Our rental and used machine service includes:

- Rental tariffs on a weekly basis
- Hire purchase
- Long-term rental

Ask us for our low rental and hire purchase conditions:

Phone: +49 (0) 77 31 792-0

Or via email under
tools@orbitalum.com

GF 8, GF 12 (AVM/MVM)

Pipe cutting and beveling machines

Cost effective pipe processing with top technology by Orbitalum Tools!

Cutting and beveling in seconds of pipes made of high-alloyed steel (special steel), low-alloyed and unalloyed steel, cast materials, plastics and non-ferrous metals according to the procedure of the "planetary cutting".

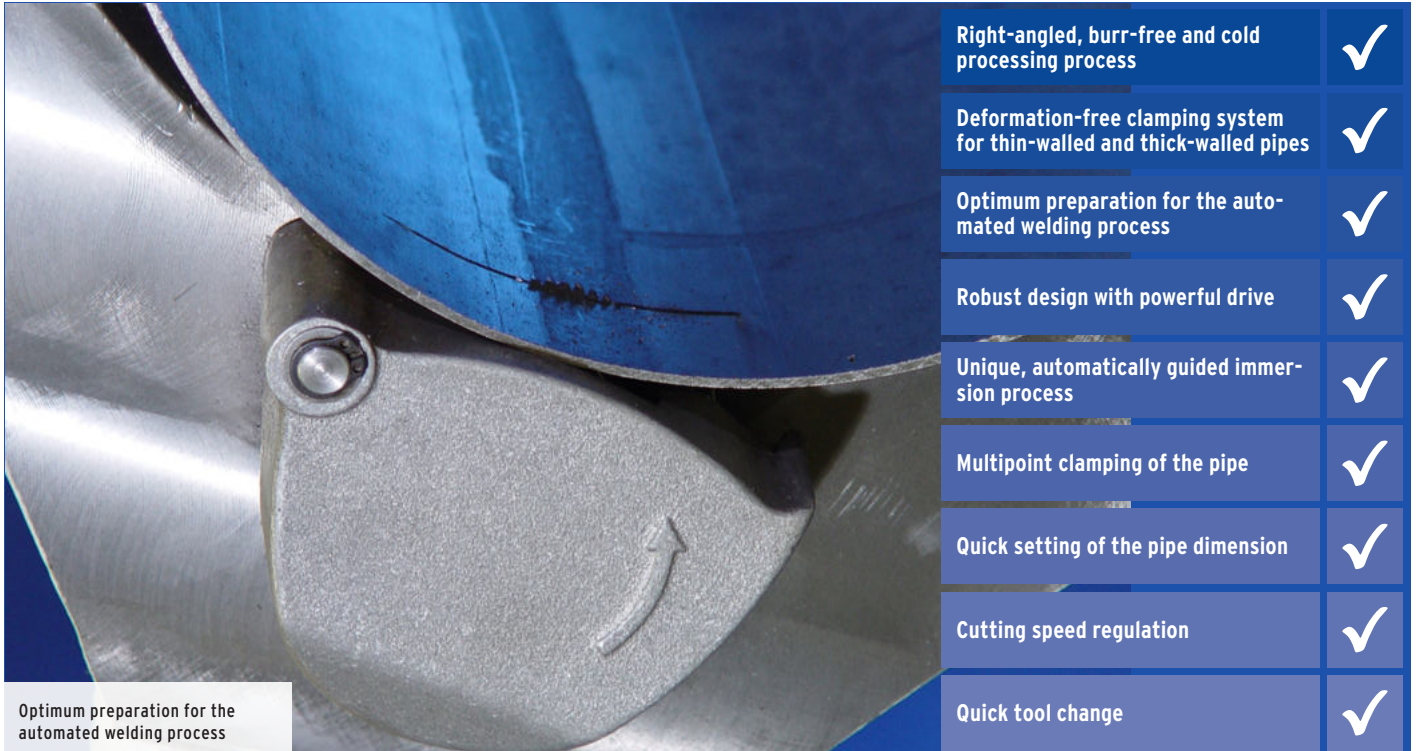

Optimum preparation for the automated welding process

Right-angled, burr-free and cold processing process	✓
Deformation-free clamping system for thin-walled and thick-walled pipes	✓
Optimum preparation for the automated welding process	✓
Robust design with powerful drive	✓
Unique, automatically guided immersion process	✓
Multipoint clamping of the pipe	✓
Quick setting of the pipe dimension	✓
Cutting speed regulation	✓
Quick tool change	✓

"Increased safety through standing pipe - rotating tool". The tried-and-tested procedure of "planetary cutting" is an important feature which is characteristic for ORBITALUM pipe saws. The saw blade immerses into the cut and is guided orbitally around the pipe. The advantage of this is that a small saw blade allows cutting a large pipe diameter without heating up the pipe.

Innovative clamping principle through multipoint clamping of the pipe: Deformation-free clamping allows pipes to be cut easily and quickly material-dependently with a wall thickness of 2 up to 10 mm (0.079" - 0.394"). You can machine all high-alloyed, unalloyed and low-alloyed steels, aluminum, copper, brass, annealed cast pipe, general structural steel, black and galvanized steel pipe and plastic. Optionally the user, apart from pure manual actuation, has the choice between a manual (MVM) and an automatic (AVM) feeding module.

The latter optimizes the cutting result, increases the service life of the tools, and reduces physical strain for the operator. The result: maximum reliability and productivity.

ADDITIONAL ADVANTAGES:

- Optionally with feeding module AVM or MVM for automatic or mechanized separation cut, thus lower physical strain for the operator.
- Optimum tool action at only one point of the pipe respectively.
- Optimized speed control (40-215 rpm), ideal for cutting high-performance materials (Hastelloy®, P91, etc.)
- Ergonomically designed motor handle, therefore safe operator position
- Separate cutting in seconds
- Beveling of pipe ends during the cutting process or separately
- Increased productivity
- Increased service life of the tools
- More corrosion protection through stainless

- steel clamping jaw attachments (included)
- Cable incl. plug connection with a quick-disconnect coupler for easy and quick replacement of power cables

FEED VARIANTS:

Pipe cutting and beveling machine with **automated feeding module AVM***: The intelligent control of the AVM continuously monitors the feed force as a function of the required output. After completion of the cutting process the AVM switches off automatically. An inadvertent startup is prevented by a restart inhibitor. Pipe cutting and beveling machines **with manual feeding module MVM***: An add-on module at the machine makes it easier to machine pipes through a manually operated handwheel. This ensures that the machine head rotates easily around the pipe user-friendly with little effort and constant feed.



Optional with feeding module AVM or MVM

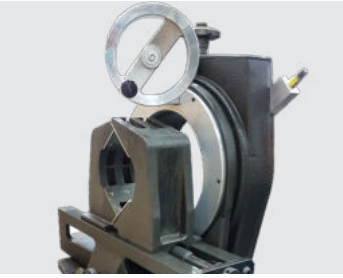

Feeding module MVM



Optimized speed range through new motor

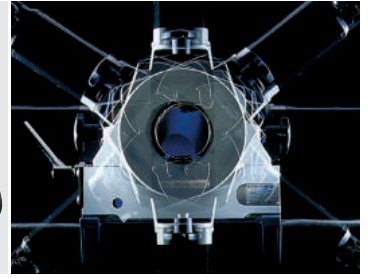

Planetary cutting principle

APPLICATION AREA		GF 8	GF 8 AVM*	GF 8 MVM*	GF 12	GF 12 AVM*	GF 12 MVM*
Code	[230 V]	790 045 095	790 045 001	790 045 069	790 047 095	790 047 001	790 047 069
	[120 V]	790 045 096	790 045 007	790 045 082	790 047 096	790 047 007	790 047 082
Pipe OD	[mm]	114 - 230	114 - 230	114 - 230	157 - 325	157 - 325	157 - 325
	[inch]	4,488 - 9,055	4,488 - 9,055	4,488 - 9,055	6,181 - 12,795	6,181 - 12,795	6,181 - 12,795
Wall-thickness depending on material	[mm]	2 - 10	2 - 10	2 - 10	2 - 10	2 - 10	2 - 10
	[inch]	0,079 - 0,394	0,079 - 0,394	0,079 - 0,394	0,079 - 0,394	0,079 - 0,394	0,079 - 0,394
Pipe ID min. (saw blade Ø 63 mm)	[mm]	137	137	137	190	190	190
Pipe ID min. (saw blade Ø 2.480")	[inch]	5.394	5.394	5.394	7.480	7.480	7.480
Pipe ID min. (saw blade Ø 68 mm)	[mm]	132	132	132	185	185	185
Pipe ID min. (saw blade Ø 2.677")	[inch]	5.197	5.197	5.197	7.283	7.283	7.283
Pipe ID min. (saw blade Ø 80 mm)	[mm]	120	120	120	173	173	173
Pipe ID min. (saw blade Ø 3.150")	[inch]	4.724	4.724	4.724	6.811	6.811	6.811
Pipe ID min. (saw blade Ø 100 mm)	[mm]	100	100	100	153	153	153
Pipe ID min. (saw blade Ø 3.937")	[inch]	3.937	3.937	3.937	6.024	6.024	6.024
Materials		Special steel (any Cr- and Mo-content); special steel stainless (any Cr- and Mo-content); special steel (Cr < 12% and Mo < 2.5%; Cr < 20% and Mo = 0%); Case hardening steels, high-speed steels, heat-treated steels, rolling bearing steels, tool steels; black and galvanized steel pipe; general structural steel; annealed cast pipe (GGG); aluminum; brass; copper; plastic (PE, PP, PVDE, PVC)					
TECHNICAL SPECIFICATIONS		GF 8	GF 8 AVM*	GF 8 MVM*	GF 12	GF 12 AVM*	GF 12 MVM*
Power	[kW]	1.8	1.9	1.8	1.8	1.9	1.8
	[hp]	2.41	2.54	2.41	2.41	2.54	2.41
Power AVM	[kW]	-	0.05	-	-	0.05	-
	[hp]	-	0.07	-	-	0.07	-
Built-in electronic speed regulation with speed stabilization	[rpm]	40 - 215	40 - 215	40 - 215	40 - 215	40 - 215	40 - 215
Rotary speed machine head with AVM	[rpm]	-	0.1 - 2.3	-	-	0.1 - 1.8	-
Torque machine head max. with AVM	[Nm]	-	165	-	-	210	-
Protection class	[Class]	II (DIN EN 60745-1)	I (DIN EN 60204-1)	II (DIN EN 60745-1)	II (DIN EN 60745-1)	I (DIN EN 60204-1)	II (DIN EN 60745-1)
Sound pressure level at the workplace approx.	[dB (A)]	79	79	79	79	79	79
Vibration level (according to DIN EN 28662, Part 1)	[m/s ²]	< 2.5	< 2.5	< 2.5	< 2.5	< 2.5	< 2.5
Mains fuse on site	[A]	16	16	16	16	16	16
Dimensions (LxDxH)	[mm]	778 x 430 x 485	918 x 430 x 485	788 x 430 x 485	940 x 374 x 592	1,070 x 374 x 592	1,090 x 374 x 592
	[inch]	30.6 x 16.9 x 19.1	36.1 x 16.9 x 19.1	31.0 x 16.1 x 19.1	37.0 x 14.7 x 23.3	42.1 x 14.7 x 23.3	42.9 x 14.7 x 23.3
Machine weight approx.**	[kg]	102.5	110.0	104.6	138.6	146.1	140.7
	[lbs]	225.9	242.5	230.6	305.6	322.1	310.2
Versions (single-phase alternating current)	[V, Hz]	230 V, 50/60 Hz 120 V, 50/60 Hz	230 V, 50/60 Hz 120 V, 50/60 Hz	230 V, 50/60 Hz 120 V, 50/60 Hz	230 V, 50/60 Hz 120 V, 50/60 Hz	230 V, 50/60 Hz 120 V, 50/60 Hz	230 V, 50/60 Hz 120 V, 50/60 Hz
SCOPE OF DELIVERY		GF 8	GF 8 AVM*	GF 8 MVM*	GF 12	GF 12 AVM*	GF 12 MVM*
Pipe cutting and beveling machine	PCS.	1	1	1	1	1	1
Transportation case	PCS.	1	1	1	1	1	1
Saw blade (Code 790 043 018)	PCS.	1	1	1	1	1	1
Mounting plate	PCS.	1	1	1	1	1	1
Line laser with fastening screws and 10 button cells 1.5 V (Code 790 142 124)	PCS.	1	1	1	1	1	1
Tool key set	Set	1	1	1	1	1	1
Saw blade lubricant GF TOP (Code 790 060 228)	Tube	1	1	1	1	1	1
Special gear oil (Code 790 041 030)	Bottle	1	1	1	1	1	1
Operating instructions with spare part list	Set	1	1	1	1	1	1

Technical specifications are non-binding. They do not constitute any assurance of properties. We reserve the right to make changes.

* The automatic or manual feeding module AVM/MVM is already mounted on the pipe saw on delivery.

** Weight without packaging and accessories.



Pipe cutting and beveling machines

GF 8, GF 12 (AVM/MVM)

Properties, application area, technical specifications and delivery scope, see from page 13.

ITEM	VERSION	CODE	MACHINE WEIGHT KG	SHIPPING WEIGHT KG
GF 8	230 V, 50/60 Hz EU	790 045 095	102.500	149.000
GF 8	120 V, 50/60 Hz EU/US	790 045 096	102.500	149.000
GF 8 AVM	230 V, 50/60 Hz EU	790 045 001	110.000	165.000
GF 8 AVM	120 V, 50/60 Hz EU/US	790 045 007	110.000	165.000
GF 8 MVM	230 V, 50/60 Hz EU	790 045 069	103.000	153.000
GF 8 MVM	120 V, 50/60 Hz EU/US	790 045 082	103.000	153.000
GF 12	230 V, 50/60 Hz EU	790 047 095	138.600	177.000
GF 12	120 V, 50/60 Hz EU/US	790 047 096	138.600	177.000
GF 12 AVM	230 V, 50/60 Hz EU	790 047 001	146.000	205.000
GF 12 AVM	120 V, 50/60 Hz EU/US	790 047 007	146.000	205.000
GF 12 MVM	230 V, 50/60 Hz EU	790 047 069	140.700	200.000
GF 12 MVM	120 V, 50/60 Hz EU/US	790 047 082	140.700	200.000

Suitable accessories:

- Saw blades and bevel cutters, see from page 26
- High quality lubricants for sawing and milling, see page 22
- Special gear oil, see page 22
- Replacement cable with rotary contact, see page 23
- Quick-mounting plates with screw clamps, see page 23
- Mobile workstation, see page 23
- Pipe feed basic unit and extension unit, see from page 24



GF 8, GF 12



GF 8 AVM, GF 12 AVM



GF 8 MVM, GF 12 MVM

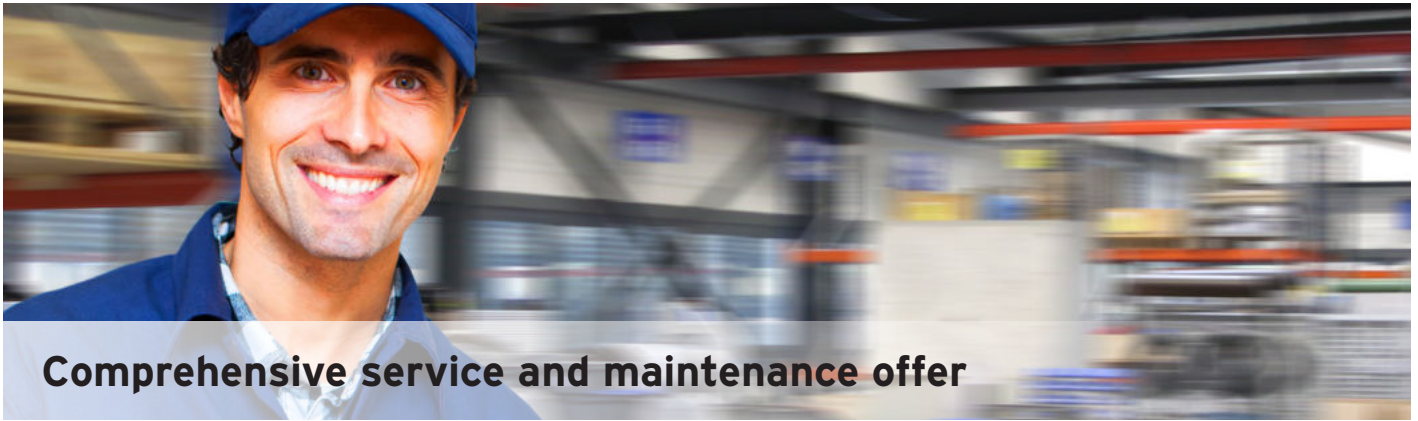

Comprehensive service and maintenance offer

We not only care about your concerns before the purchase. You can rely completely on us after your purchase as well.

Our products are extremely robust and reliable.

To ensure the performance in the long run, the recommended service and maintenance intervals should be performed regularly. All service and maintenance work is performed with great care by qualified and motivated employees. They analyze your situation to find the best long-term solution.

We offer competent service via branches as well as our worldwide network of authorized partners. These are carefully selected and are regularly trained by our experts to always be up-to-date with regard to products and technologies.

Why maintenance?

"Prevention is better than cure"

Better not wait until your machine sooner or later breaks down completely because of a lack of service or maintenance! Small causes can often have large effects, and failures or malfunctions could have been avoided with timely control or maintenance.

When did you have your machine serviced the last time?
Better to arrange a meeting now:



+49 (0) 77 31 792-786



customerservice@itw-ocw.com

Do not forget: Fill out the service form!

The service form can be downloaded under: www.orbitalum.de/service.html

Our services:

- Repairing, replacing
- Cost quotation
- Proactive maintenance
- Service training for customers
- Rental machines for bridging repair periods with special conditions
- Collection service for machines
- Visual and functional test
- Determination and measurement technical parameters
- Discussion with customer about maintenance result
- Functional test of the system components
- Cleaning and maintenance work
- Exchange defined wear parts as well as defective components
- Implementation of modifications, in as far as this serves the technical improvements of the device
- Required adjustment and set-up tasks including calibration and new inspection

Your advantages:

- Service directly by the manufacturer or authorized partner
- Reduced downtimes
- Long-term functioning of your machines and plants
- Ensuring high availability
- Wear discovered at an early stage avoids unnecessary and expensive repairs
- Reducing the failure susceptibility
- Value preservation of your machines and plants
- Regular services ensure reliable machine operation - even after years
- Relief of in-house service employees

GFX 3.0, GFX 6.6

Pipe cutting and beveling machines

Innovative saws by Orbitalum Tools for cutting and beveling pipes and for cutting off tube elbows (even for thin-walled special steel) in just seconds. Optimum preparation for the automated welding process! The GFX is an easy to operate, powerful and compact saw with low weight - convince yourself of the many outstanding features of this machine.

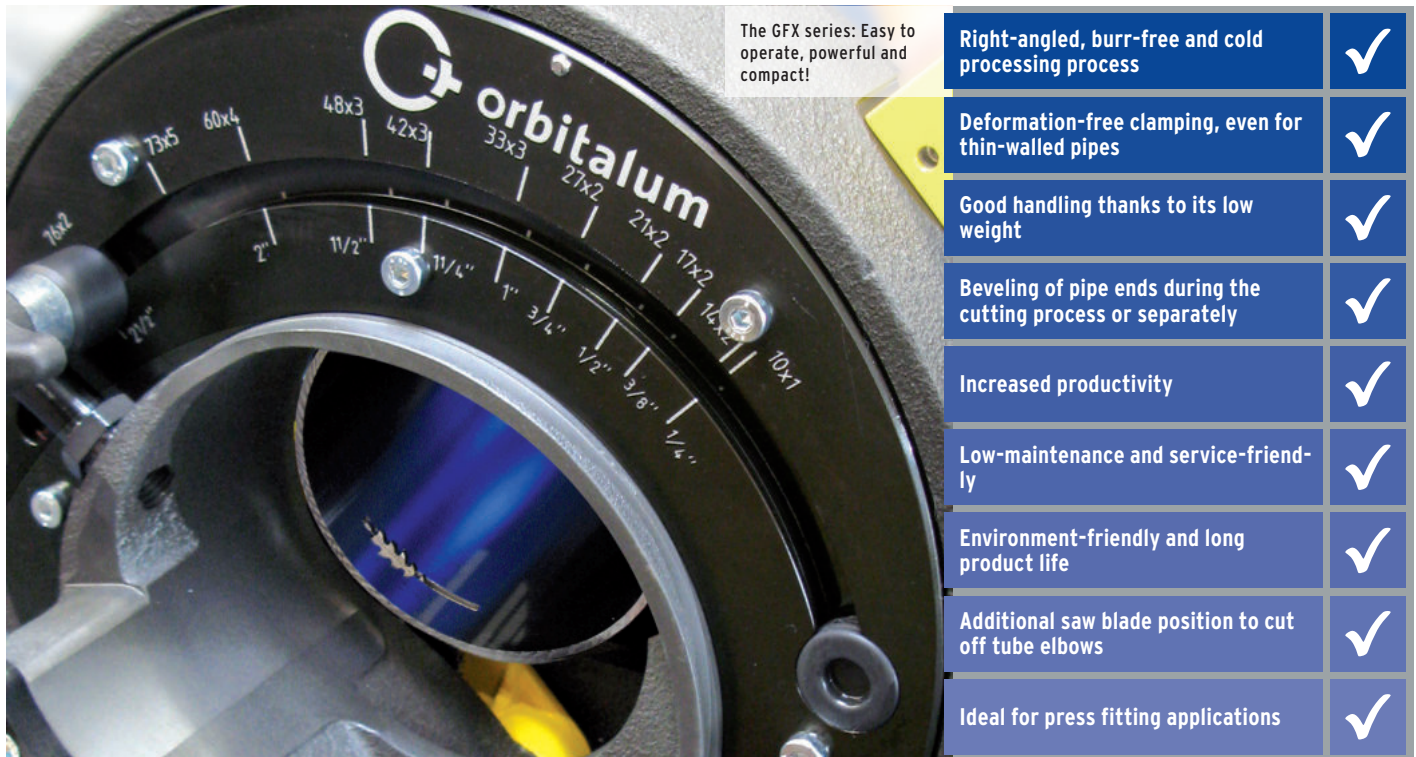

The GFX series: Easy to operate, powerful and compact!

Right-angled, burr-free and cold processing process	✓
Deformation-free clamping, even for thin-walled pipes	✓
Good handling thanks to its low weight	✓
Beveling of pipe ends during the cutting process or separately	✓
Increased productivity	✓
Low-maintenance and service-friendly	✓
Environment-friendly and long product life	✓
Additional saw blade position to cut off tube elbows	✓
Ideal for press fitting applications	✓

Our GFX series is ideal for cutting thin-walled tubes. Due to the rugged design for a long product the saws are especially economical; long tool lives also increase productivity.

The GFX is low-maintenance and service-friendly and offers a large area of application. Processable materials include unalloyed, low-alloyed and high-alloyed steel, special steel, non-ferrous metal aluminum alloys and titanium alloys.

As is meanwhile characteristic for the ORBITALUM pipe saws, they allow convenient marking of the cut-off point on the tube with a line laser. A second saw blade clamping point enables tube elbows to be cut off.

The powerful motor is equipped with overload protection and ergonomic handles and is available for the voltages 230 V, 50/60 Hz or 120 V, 50/60 Hz.

The cable connection with a quick-release screw coupler enables simple, convenient replacement of the flexible swivel cable.

The applications lie mainly in the food processing, beverage, pharmaceutical and chemical industries.

ADDITIONAL ADVANTAGES:

- Optimized chip flow due to new vice design
- Steel sliding clamping jaws with stainless steel clamping attachments
- Integrated line laser to mark the cut-off point
- Ergonomically designed motor handle
- Drive with high performance (1,200 W) and adjustable speed range for cutting a wide range of materials
- Electronic overload protection with integrated temperature monitor and tachometer control

- Increased service life of the tools through the new GF10 drive
- Ergonomically positioned speed adjusting wheel
- Plug connection with a quick-disconnect coupler: easy and quick replacement of the swivel cable
- Direct mounting on workbench possible at GFX 3.0



Including second saw blade position to cut off tube elbows

Including steel sliding clamping jaws with sets of stainless steel caps

Integrated line laser for cut-off marking on the pipe

Powerful motor with overload protection and ergonomic handles

Including GF TOP saw blade lubricant

Right-angled and burr-free processing - ideal for press fitting applications

APPLICATION AREA		GFX 3.0	GFX 6.6
Code	[230 V]	790 144 001	790 146 001
	[120 V]	790 144 002	790 146 002
Pipe OD	[mm]	6.0 - 78.0	21.3 - 168.3
	[inch]	0,236 - 3,071	0,838 - 6,659
Wall thickness	[mm]	0.8 - 7.0	0.8 - 7.0
	[inch]	0,031 - 0,275	0,031 - 0,275
Pipe ID min. (saw blade Ø 63/2.248")	[mm]	0	23.0
	[inch]	0	0.905
OD range (saw blade Ø 63/2.248")	[mm]	6.0 - 78.0	24.6 - 168.3
	[inch]	0,236 - 3,071	1,008 - 6,659
Pipe ID min. (saw blade Ø 68/2.677")	[mm]	0	18
	[inch]	0	0.708
OD range (saw blade Ø 68/2.677")	[mm]	6.0 - 73.0	21.3 - 168.3
	[inch]	0,236 - 2,874	0,838 - 6,659
Pipe ID min. (saw blade Ø 80/3.149")	[mm]	-	6.0
	[inch]	-	0.236
OD range (saw blade Ø 80/3.149")	[mm]	-	21.3 - 156.0
	[inch]	-	0,838 - 2,205
Materials	Unalloyed, low-alloyed and high-alloyed steel, special steel, non-ferrous metal aluminum alloys and titanium alloys, composites, plastic		
TECHNICAL SPECIFICATIONS		GFX 3.0	GFX 6.6
Dimensions (LxDxH)	[mm]	570 x 330 x 280	575 x 350 x 671
	[inch]	22.44 x 12.99 x 11.02	22.64 x 13.78 x 26.42
Weight incl. vice	[kg]	28.5	74.4
	[lbs]	62.83	164.02
Power	[W]	1200	1200
Protection class	[Class]	II	II
Built-in electronic speed regulation with speed stabilization	[rpm]	30 - 200	30 - 200
Versions (single-phase alternating current)	[V, Hz]	230 V, 50/60 Hz EU	230 V, 50/60 Hz EU
	[V, Hz]	120 V, 50/60 Hz US	120 V, 50/60 Hz US
Vibration level (EN 50144)	[m/s ²]	< 2.5	< 2.5
Sound pressure level at the workplace (EN 23741)	[dB (A)]	79.7	79.7
SCOPE OF DELIVERY		GFX 3.0	GFX 6.6
Pipe cutting and beveling machine	PCS.	1	1
Transportation case	PCS.	1	1
Saw blade (Code 790 ...)	PCS.	1 (...041 035)	1 (...042 064)
Quick-mounting plate without screw clamps*	PCS.	-	1
Line laser with holder and fastening screws and 10 button cells 1.5 V (Code 790 142 124)**	PCS.	1	1
Tool key set	Set	1	1
Saw blade lubricant GF TOP (Code 790 060 228)	Tube	1	1
Operating instructions with spare part list	Set	1	1



GFX 3.0, GFX 6.6

Technical specifications are non-binding. They do not constitute any assurance of properties. We reserve the right to make changes.

- * The GFX 3.0 can be mounted directly on the workbench without a quick-mounting plate. Quick-mounting plates with screw clamps for GFX 3.0 and GFX 6.6 are available optionally.
- ** The line laser has to be mounted on the GFX before commissioning

Pipe cutting and beveling machines

GFX 3.0, GFX 6.6

Properties, application area, technical specifications and delivery scope, see page 17.

ITEM	VERSION	CODE	MACHINE WEIGHT KG	SHIPPING WEIGHT KG
GFX 3.0	230 V, 50/60 Hz EU	790 144 001	28.000	44.000
GFX 3.0	120 V, 50/60 Hz US	790 144 002	28.000	44.000
GFX 6.6	230 V, 50/60 Hz EU	790 146 001	74.400	104.000
GFX 6.6	120 V, 50/60 Hz US	790 146 002	74.400	104.000



GFX 3.0, GFX 6.6

Hard-sided transport case

High-quality, blue transport case with insert. Especially robust design.

ITEM	CODE	KG
Hard-sided transport case for GFX 3.0	790 144 019	12.500



Hard-sided transport case

Other accessories

- Saw blades and bevel cutters, see from page 26
- High quality lubricants for sawing and milling, see page 22
- Replacement cable with rotary contact, see page 23
- Quick-mounting plates with screw clamps, see page 23
- Mobile workstation, see page 23
- Pipe feed basic unit and extension unit, see from page 24
- Tripod, see page 34
- Folding workbench, see page 80

Accessories for GF machines

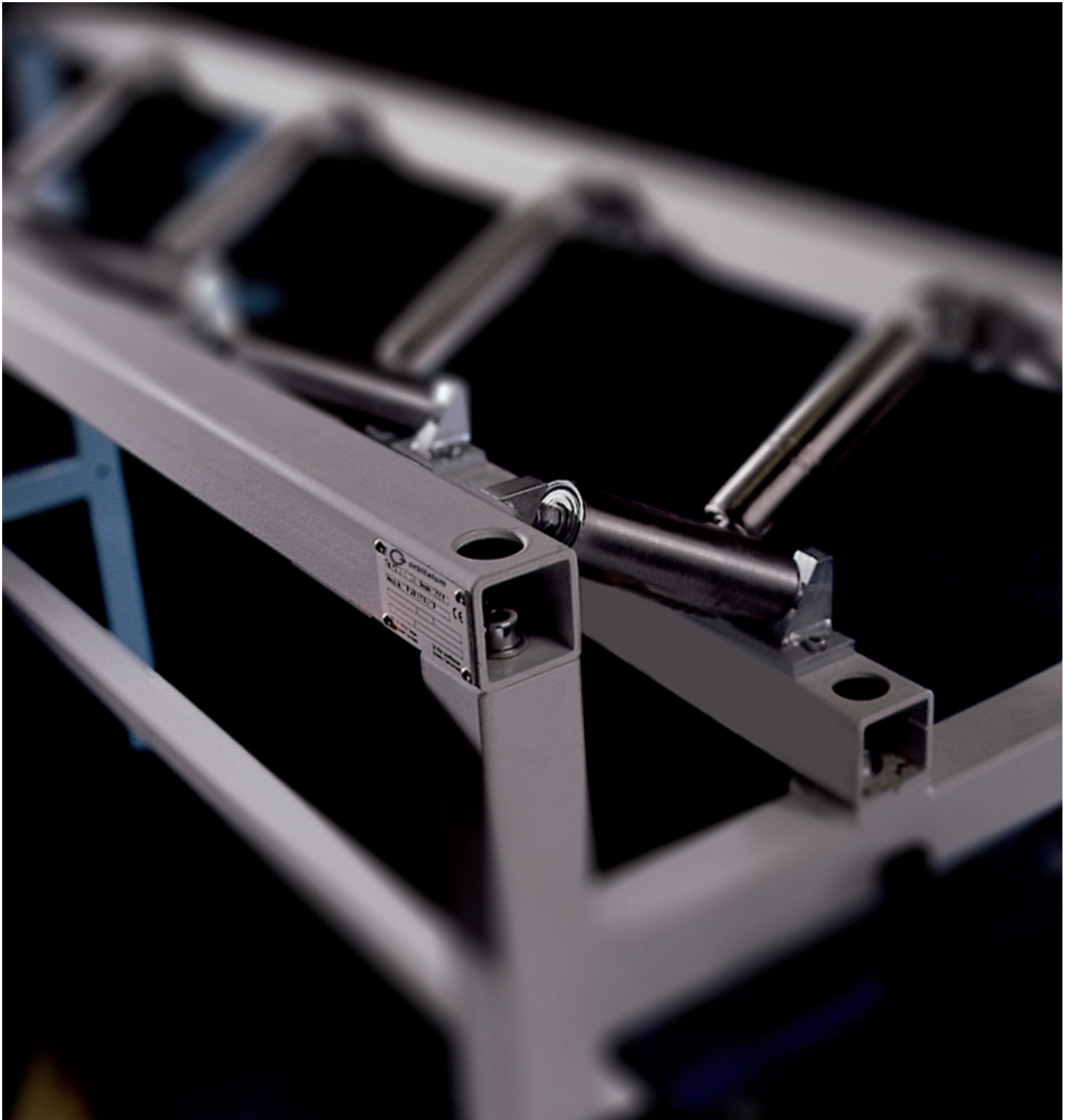



GF TOP



GF LUB



Special gear oil

Accessories for GF machines

Saw blade lubricant GF TOP

Synthetic high quality lubricant for sawing and milling.

Increases the service life of the saw blade.

Fulfills the requirements for H2 lubricants.

Thanks to the screw-on brush, simple and even lubrication of the saw blade is ensured.

ITEM	VERSION	CODE	KG
Saw blade lubricant GF TOP	Tube, 180 g	790 060 228	0.205

Saw blade lubricating paste GF LUB

Chlorine-free high quality lubricant for sawing and milling.

Increases the service life of the saw blade.

The ecological lubricating paste is the environment-friendly successor of ROCOL; with new name and improved quality.

GF LUB complies with latest environmental guidelines and ecological standards.

ITEM	VERSION	CODE	KG
Saw blade lubricating paste GF LUB	Tube, 160 ml	790 041 016	0.160

Special gear oil

For all GF and RA types.

ITEM	VERSION	CODE	KG
Special gear oil	Bottle, 250 ml	790 041 030	0.235

Replacement cable with rotary contact

Prevents twisting of the cable.
For GF, RA and PS machines with protection class II.

ITEM	VERSION	CABLE LENGTH		CODE	KG
		[M]	[FT]		
Swivel cable complete	230 V, 50/60 Hz EU	4	13.12	790 142 081	0.680
Swivel cable complete	120 V, 50/60 Hz US/CA	4	13.12	790 142 082	0.654
Swivel cable complete	230 V, 50/60 Hz CH	4	13.12	790 142 083	0.595
Swivel cable complete	230 V, 50/60 Hz AU	4	13.12	790 142 084	0.655
Swivel cable complete	120 V, 50/60 Hz GB	4	13.12	790 142 087	0.740
Swivel cable	230 V, 50/60 Hz EU	4	13.12	790 142 076	0.560
Swivel cable	120 V, 50/60 Hz US/CA	4	13.12	790 142 077	0.740
Swivel cable	230 V, 50/60 Hz CH	4	13.12	790 142 078	0.520
Swivel cable	120 V, 50/60 Hz GB	4	13.12	790 142 079	0.630
Swivel cable	230 V, 50/60 Hz AU	4	13.12	790 142 080	0.560



Swivel cable complete



Swivel cable

Quick-mounting plates with screw clamps

For fast mounting of the machines on workbenches.
Ideal for frequently changing operation locations.

ITEM	CODE	KG
Quick-mounting plate for GFX 3.0, RA 2, RA 21 S	790 041 027	4.230
Quick-mounting plate for GF 4, GF 6, GFX 6.6, RA 4, RA 6, GF 8, RA 41 Plus	790 042 027	6.165
Quick-mounting plate for PS 4.5, PS 4.5 Plus and PS 6.6	790 048 334	2.600



Quick-mounting plate with screw clamps

Mobile workstation

For mobile construction site and workshop use
The ideal supplement for all Orbitalum pipe saws (excluded PS 4.5 Plus).

Advantages:

- Safe transport of the machines to the construction side
- Flexible work on the respective work stations
- Elimination of setup times, e.g. mounting the pipe saw on workbenches
- Height-adjustable roller pipe support with stainless steel roller for supporting the pipes
- Lockable toolbox with 4 compartments for tool and accessories
- Threaded lifting table to adjust the height of the machines to the respective pipe dimension
- Collection tray for chips



Mobile workstation

TECHNICAL SPECIFICATIONS	MOBILE WORKSTATION
Dimensions (LxDxH)	115 x 43 x 91 cm 45.3" x 16.9" x 35.8"
Load capacity max.	675 kg 1488.1lbs

ITEM	CODE	KG
Mobile workstation	790 068 071	137.000

PIPE CUTTING AND BEVELING TECHNOLOGY



Pipe feeder basic unit



Pipe feeder extension unit

Pipe feeder basic unit and extension unit

The pipe feeder allows you to feed long and heavy pipes effortlessly and coaxially to the GF machines. Very robust and stable design with powder-coated frame and stainless steel rollers.

Advantages:

- Extreme stability and structural stability
- Rapid adjustment of dimensions
- Centering of pipes in seconds
- Specially coated, maintenance-free steel frame
- Stainless-steel rollers
- Extension of pipe feeder possible with add-on module
- Saves time and money
- Suitable for all steels

Basic unit:

Fitting for all pipe cutting and beveling machines by Orbitalum Tools (excluded GFX 3.9 PS 4.5 Plus possible on request). The machines can be mounted directly and without special accessories on the mounting plate of the basic unit. Thanks to mechanical height-adjustment by means of a handwheel, the machine can be easily adjusted to the outer diameter of the pipe to be cut. The machine is spring-loaded on the mounting plate.

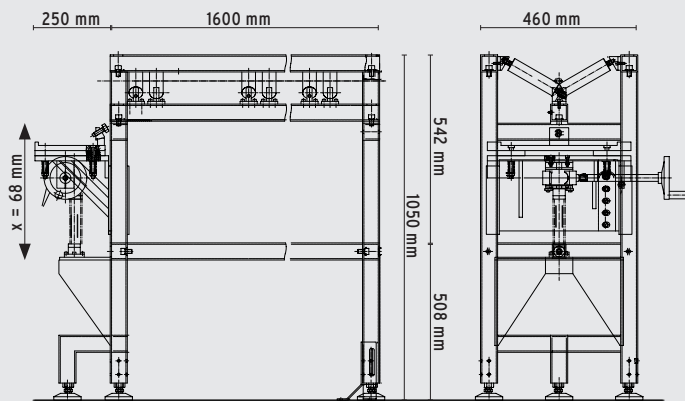

x = adjustment distance

Extension unit:

For individual extension of the basic unit. Can be connected directly to the basic unit.

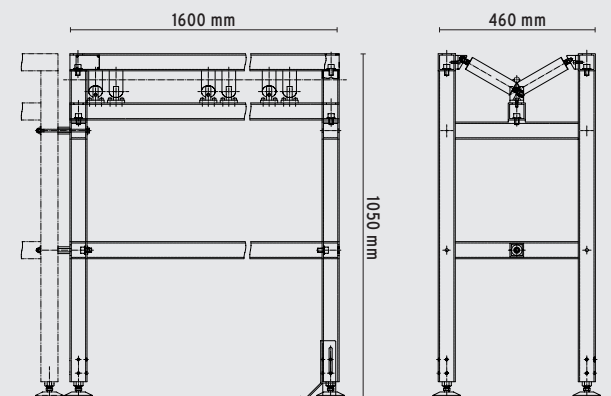

Floor bracket assembly:

For attaching the basic and extension unit to the floor.
 The assembly consists of 4 bracket elements and 8 screws with flat washers.

APPLICATION AREA/ TECHNICAL SPECIFICATIONS	PIPE FEED BASIC UNIT	PIPE FEED EXTENSION UNIT
Pipe OD	16 - 325 mm 0.63" - 12.8"	16 - 325 mm 0.63" - 12.8"
Dimensions approx.	185 x 105 x 50 cm 72.8" x 41.3" x 19.7"	Approx. 160 x 105 x 50 62.9" x 41.3" x 19.7"
Load capacity max.	400 kg 881.8 lbs	400 kg 881.8 lbs
Height-adjustable quick-mounting plate (adjustment distance)	68 mm 2.68"	- -

ITEM	CODE	KG
Pipe feeder basic unit	790 068 051	116.000
Pipe feeder extension unit	790 068 061	72.000
Floor bracket assembly	790 068 053	1.900

Other accessories

- Saw blades and bevel cutters, see from page 26
- Folding workbench, see page 80

Saw blades and bevel cutters

for GF and GX machines

The saw blades are developed specifically for our pipe saws for extreme demands and maximum service life. For the different applications 4 different saw blades and bevel cutter designs are available.



Precise, right-angled and burr-free cut through high quality materials, innovative manufacturing methods and special cutting geometrics



Burr- and deformation-free

Right-angled

Cutting and beveling

- **Economy** series for low-alloyed and unalloyed steels as well as cast materials
- **Performance** series for high-alloyed steels (special steel)
- **High-Performance** series for high-performance materials and high-alloyed steels
- **Premium** series specifically for special steel applications with extra high service life

PROCESSABLE MATERIALS	AL	UNALLOYED STEEL, CU, CUNI, CUZN, CUSN	INOX, V2A, V4A, 304, 316 (L)	TI, DUPLEX, INCONEL
Economy	*	*		
Performance		*	*	
High-Performance		*	*	*
Premium			*	

Technical specifications are non-binding. They do not constitute any assurance of properties. We reserve the right to make changes.

Saw blades and bevel cutters for GF machines

Saw blades

Properties and areas of application, see page 26.

Some saw blades are available in economical packs of 10 (with individual packaging) - meaning that you save 30% on the normal list price when you buy these value packs!

When ordering please note that the pack of 10 has a different code number.



Saw blade Economy



Saw blade Performance



Saw blade High-Performance



Saw blade Premium



Saw blade with additional hole



ITEM	VERSION	PIPE WALL THICKNESS		SAW BLADE Ø		PACK WITH 1 PC		PACK WITH 10 PCS
		[MM]	[INCH]	[MM]	[INCH]	CODE	KG	CODE
Saw blade	Economy*	1.5 - 6.0	0,059 - 0,236	68	2,677	790 042 063	0.036	792 042 063
Saw blade	Economy	2.0 - 5.5	0,079 - 0,217	63	2,480	790 041 020	0.032	792 041 020
Saw blade	Economy*	5.0 - 12.0	0,197 - 0,472	80	2,953	790 043 030	0.075	792 043 030
Saw blade	Performance	0.6 - 1.2	0,024 - 0,047	63	2,480	790 041 036	0.027	792 041 036
Saw blade	Performance	1.0 - 1.6	0,039 - 0,063	68	2,677	790 042 049	0.050	792 042 049
Saw blade	Performance	1.0 - 3.0	0,039 - 0,118	63	2,480	790 048 072	0.035	792 048 072
Saw blade	Performance	1.2 - 2.5	0,047 - 0,098	63	2,480	790 041 035	0.040	792 041 035
Saw blade	Performance	1.2 - 2.5	0,047 - 0,098	68	2,677	790 042 064	0.045	792 042 064
Saw blade	Performance**	1.2 - 2.5	0,047 - 0,098	100	3,937	790 043 036	0.104	792 043 036
Saw blade	Performance	1.2 - 3.0	0,047 - 0,118	83	3,268	790 043 024	0.075	792 043 024
Saw blade	Performance	1.5 - 2.5	0,059 - 0,098	80	3,150	790 046 022	0.065	792 046 022
Saw blade	Performance	2.5 - 5.5	0,098 - 0,217	63	2,480	790 041 048	0.035	792 041 048
Saw blade	Performance**	2.5 - 5.5	0,098 - 0,217	100	3,937	790 043 038	0.120	792 043 038
Saw blade	Performance	2.5 - 7.0	0,098 - 0,276	68	2,677	790 042 048	0.045	792 042 048
Saw blade	Performance	2.5 - 7.0	0,098 - 0,276	80	3,150	790 043 018	0.080	792 043 018
Saw blade	Performance	6.0 - 10.0	0,236 - 0,394	80	2,953	790 043 022	0.075	792 043 022
Saw blade	Performance**	6.0 - 15.0	0,236 - 0,591	100	3,937	790 047 026	0.105	792 047 026
Saw blade	High-Performance	1.2 - 2.5	0,047 - 0,098	80	3,150	790 046 021	0.064	
Saw blade	High-Performance	1.2 - 2.5	0,047 - 0,098	63	2,480	790 041 034	0.040	
Saw blade	High-Performance	2.5 - 7.0	0,098 - 0,267	68	2,677	790 042 058	0.045	
Saw blade	Premium	1.2 - 2.5	0,047 - 0,098	63	2,480	790 041 049	0.033	
Saw blade with hole	Performance	1.0 - 3.0	0,039 - 0,118	63	2,480	790 048 472	0.035	792 048 472
Saw blade with hole	Performance	1.2 - 2.5	0,047 - 0,098	63	2,480	790 041 435	0.030	792 041 435
Saw blade with hole	Performance	1.2 - 2.5	0,047 - 0,098	68	2,677	790 042 464	0.047	792 042 464
Saw blade with hole	Performance	1.5 - 2.5	0,059 - 0,098	80	3,150	790 046 422	0.052	792 046 422
Saw blade with hole	Performance	2.5 - 7.0	0,098 - 0,276	68	2,677	790 042 448	0.036	792 042 448

* Can only be used for aluminum pipes

** Only for GF 6, RA 6, GF 8, GF 12 and GF 20 AVM

PIPE CUTTING AND BEVELING TECHNOLOGY



Weld seam saw blade bevel cutter combination (V-seam)

Saw blade bevel cutter combinations

Properties and areas of application, see page 26.
Simultaneous cutting and beveling in just seconds.

Weld seam saw blade bevel cutter combinations (V-seam)

Consisting of one saw blade and one bevel cutter each.
Individual parts can also be ordered separately.

VERSION	PIPE WALL THICKNESS		BEVELING ANGLE [°]	BEVELING HEIGHT MAX.		SAW BLADE Ø		CODE	KG
	[MM]	[INCH]		[MM]	[INCH]	[MM]	[INCH]		
Performance	1.2 - 3.0	.047 - .118	30	3	.118	63	2.480	790 044 050	0.100
Performance	2.5 - 7.0	.098 - .276	30	7	.276	68	2.677	790 042 161	0.108
High-Performance	2.5 - 5.0	.098 - .197	35	5	.197	68	2.677	790 042 015	0.120
High-Performance	2.5 - 6.0	.098 - .236	45	4	.157	68	2.677	790 042 023	0.135
High-Performance	2.5 - 7.0	.098 - .276	30	7	.276	68	2.677	790 042 013	0.108

Individual parts to weld seam saw blade bevel cutter combinations (V-seam)

ITEM	VERSION	CODE	KG
Saw blade for 790 044 050	Performance	790 044 040	0.027
Bevel cutter 30° for 790 044 050	Performance	790 044 049	0.065
Saw blade for 790 042 155, 790 042 157 and 790 042 161	Performance	790 042 153	0.040
Bevel cutter 30° for 790 042 161	Performance	790 042 160	0.060
Saw blade for 790 042 018, 790 042 015, 790 042 023, 790 042 013	High-Performance	790 042 016	0.040
Bevel cutter 30° for 790 042 013	High-Performance	790 042 021	0.077
Bevel cutter 35° for 790 042 015	High-Performance	790 042 014	0.060

Supporting ring for saw blade bevel cutter combinations

We recommend using 1 ring for the saw blade bevel cutter combinations.

ITEM	CODE	KG
Supporting ring	790 046 188	0.068



Press fitting saw blade bevel cutter combination

Press fitting saw blade bevel cutter combinations

Consisting of one saw blade and one bevel cutter each.
Especially suitable for pipes of metal press fitting systems.
Individual parts can also be ordered separately.

VERSION	PIPE WALL THICKNESS		BEVELING ANGLE [°]	BEVELING HEIGHT MAX.		SAW BLADE Ø		CODE	KG
	[MM]	[INCH]		[MM]	[INCH]	[MM]	[INCH]		
Performance	1.0 - 2.0	.039 - .079	45/70	0.4/1.0	.016/.039	63	2.480	790 044 046	0.090

Individual parts for press fitting saw blade bevel cutter combinations

ITEM	VERSION	CODE	KG
Saw blade for 790 044 046	Performance	790 044 040	0.027
Bevel cutter for 790 044 046	Performance	790 044 042	0.064

Chamfer cutter

Properties and areas of application, see page 26.

For realizing V-seam welding joints at pipe ends.

Instead of the saw blade the chamfer cutter is mounted on the GF/RA pipe saw. Reproducible weld seam preparation in just seconds.

Chamfer cutter V-seam

ITEM	BEVELING ANGLE [°]	BEVELING HEIGHT MAX.		BEVEL CUTTER Ø		CODE	KG
		[MM]	[INCH]	[MM]	[INCH]		
Economy	30.0	9.5	.374	72	2.835	790 042 045	0.165
Economy	35.0	8.9	.350	70	2.756	790 042 037	0.170
Economy	37.5	8.4	.331	70	2.756	790 042 036	0.162
Economy	45.0	7.5	.295	70	2.756	790 042 038	0.162
Performance	30.0	9.5	.374	72	2.835	790 042 071	0.153
Performance	30.0	13.0	.512	76	2.992	790 043 023	0.187
Performance	37.5	8.4	.331	70	2.756	790 042 070	0.163
High-Performance	30.0	9.5	.374	72	2.835	790 042 073	0.157



Chamfer cutter V-seam

Saw blade lubricant GF TOP

Synthetic high quality lubricant for sawing and milling.

Increases the service life of the saw blade.

Fulfills the requirements for H2 lubricants.

Thanks to the screw-on brush, simple and even lubrication of the saw blade is ensured.

ITEM	VERSION	CODE	KG
Saw blade lubricant GF TOP	Tube, 180 g	790 060 228	0.205



GF TOP

Saw blade lubricating paste GF LUB

Chlorine-free high quality lubricant for sawing and milling.

Increases the service life of the saw blade.

The ecological lubricating paste is the environment-friendly successor of ROCOL; with new name and improved quality.

GF LUB complies with latest environmental guidelines and ecological standards.

ITEM	VERSION	CODE	KG
Saw blade lubricating paste GF LUB	Tube, 160 ml	790 041 016	0.160



GF LUB



TCT Saw Blade



Diamond Cutting Blade



Cermet Saw Blade

Saw blades for SCORP machines

TCT saw blade

AREA OF APPLICATION SCORP 360 WITH TCT SAW BLADES

Plastic pipe OD		Saw blade Ø 140mm/5.512" max. wall-thickness	
[mm]	[inch]	[mm]	[inch]
75	2.953	15.1	0.594
90	3.543	11.4	0.449
100	3.937	10.1	0.398
110	4.331	9.3	0.366
115	4.528	9.1	0.358
125	4.921	8.8	0.346
140	5.512	8.7	0.343
160	6.299	9.1	0.358
165	6.496	9.3	0.366
180	7.087	9.9	0.390
190	7.480	10.4	0.409
200	7.874	10.9	0.429
215	8.465	11.8	0.465
225	8.858	12.4	0.488
240	9.449	13.4	0.528
250	9.843	14.0	0.551
270	10.630	15.4	0.606
280	11.024	16.0	0.630
315	12.402	18.3	0.720
320	12.598	18.6	0.732
355	13.976	20.4	0.803

ITEM	CUTTABLE MATERIALS	SAW BLADE Ø		RPM MAX.	CODE	KG
		[MM]	[INCH]			
TCT Saw Blade	Steel, copper, aluminum, plastic	140	5.512	4.200	790 014 055	0.154

Diamond cutting blade

ITEM	CUTTABLE MATERIALS	SAW BLADE Ø		RPM MAX.	CODE	KG
		[MM]	[INCH]			
Diamond Cutting Blade*	Cast pipe	155	6.102	4.200	790 014 059	0.215

* Only for SCORP 360. Only while supplies last.

Cermet saw blade

ITEM	CUTTABLE MATERIALS	SAW BLADE Ø		RPM MAX.	CODE	KG
		[MM]	[INCH]			
Cermet Saw Blade	Stainless steel	140	5.512	4.200	790 014 056	0.153

PS 4.5 Plus

Portable pipe saw

A mobile, powerful and flexible pipe cutting machine for construction site usage - this is what the PS saw by Orbitalum Tools stands for. This pipe saw not only convinces by a burr-free, right-angled and deformation-free cutting result but also by the low machine weight. At the same time, the problem-free and easy usability are paramount for users apart from the unbeatable price.

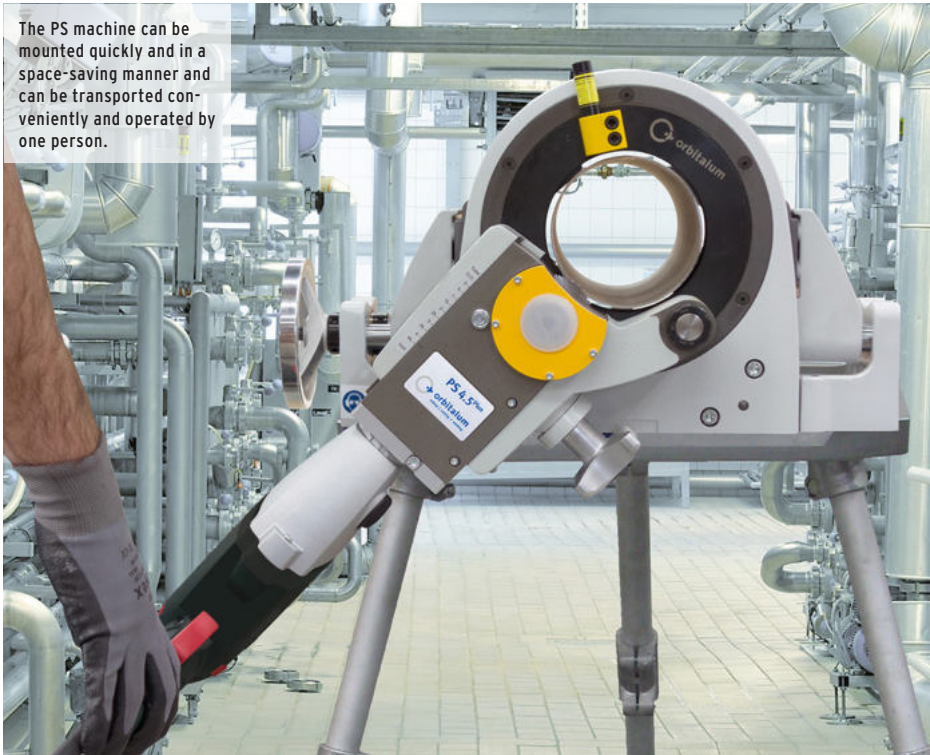

The PS machine can be mounted quickly and in a space-saving manner and can be transported conveniently and operated by one person.

Sophisticated technology - problem-free and easy operation	✓
In this field of application the lightest machine on the market	✓
Integrated line laser to mark the cut-off point	✓
Feeding and sawing in one work cycle	✓
High quality and long service life through robust sliding components	✓
Mobility through low machine weight, thus ideal for flexible use on the construction site	✓
Deformation-free clamping, through integrated clamping jaws	✓
For cutting thin-walled pipes and for cutting tube elbows	✓
Post-processing free through burr-free and right-angled cut	✓

Cutting thin-walled stainless steel pipes and tube elbows according to the "planetary cutting principle" - easier than ever before! In this field of application the PS 4.5 Plus (23 kg) is among the lightest machines available on the market.

"Increased safety through standing pipe - rotating tool". The tried-and-tested procedure of "planetary cutting" is an important feature which is characteristic for ORBITALUM pipe saws. The saw blade immerses into the cut and is guided orbitally around the pipe. The advantage of this is that a small saw blade allows cutting a large pipe diameter without heating up the pipe.

As with most ORBITALUM pipe saws, they allow

convenient marking of the cut-off point on the tube with a line laser. A second saw blade clamping point enables tube elbows to be cut off. The powerful motor is equipped with overload protection and ergonomic handles and is available for the voltages 230 V, 110 V or 120 V, 50/60 Hz.

The machine head as well as the self-centering vice are manufactured of high quality aluminum alloys, which fulfill the highest construction site requirements.

ADDITIONAL ADVANTAGES:

- Corrosion prevention through cold processing process
- Integrated line laser to mark the cut-off point
- Saving of time through orbital cutting process
- Multipoint clamping of the pipe
- Quick setting of the pipe dimension
- High tool service life
- Use of press fitting saw blade combinations possible*
- Speed controlled single-phase alternating current motor with restart inhibitor

* Only with the Orbitalum saw blade bevel cutter combinations, Code 790 044 046 or Code 790 044 047. Especially suitable for pipes of metal press fitting systems. Consisting of one saw blade and one bevel cutter each. Individual parts can also be ordered separately. Processable wall thickness: 1-2 mm, beveling angle: 45°/70°, beveling height: max. 0.4/1.0 mm.



Supply in hard-sided transport case with compartments for accessories, e.g. for mounting plate, tools and now also for tripods (available optionally)



Self-centering vice made of high quality aluminum alloy

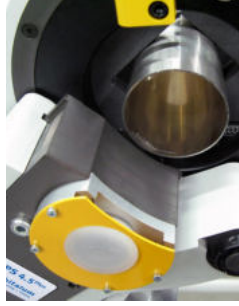

Tried-and-tested planetary cutting principle: The saw blade immerses into the cut and is guided orbitally around the pipe



Including "Performance" saw blade (790 048 072) and saw blade lubricant GF TOP



Additional saw blade position to cut off tube elbows



Tripod made of aluminum available optionally. Dismountable in few steps - for space-saving storage, e.g. in PS transport case

APPLICATION AREA		PS 4.5 Plus
Code	[230 V]	790 048 001
	[110 V]	790 048 002
	[120 V]	790 048 003
Outer Ø D0 pipes	[mm]	6 - 120
	[inch]	0,236 - 4,724
Outer Ø D0 tube elbows	[mm]	30 - 120
	[inch]	1,181 - 4,724
Wall thickness min. - max.	[mm]	0.6 - 3.0
	[inch]	0,024 - 0,118
TECHNICAL SPECIFICATIONS		
Dimensions	[mm]	480 x 230 x 600
	[inch]	20.9 x 9.1 x 23.6
Power	[W]	1100
	[hp]	1.5
Protection class (DIN VDE 0740, protective insulated)	[Class]	II
Speed	[rpm]	30 - 165
Vibration level (DIN EN 28662, Part 1)	[m/s ²]	< 2,5
Sound pressure level at the workplace approx.	[dB (A)]	78
SCOPE OF DELIVERY		
Portable pipe saw	PCS.	1
Clamping jaws made of hardened cast aluminum	Set	1
Hard-sided transport case	PCS.	1
Line laser*	PCS.	1
Saw blade (Code 790 048 072)	PCS.	1
Tool bag incl. accessories (roll-up case Code 790 048 345)	PCS.	1
Operating instructions with spare part list	Set	1



PS 4.5 Plus

Technical specifications are non-binding. They do not constitute any assurance of properties. We reserve the right to make changes.

*Line laser already mounted at machine on delivery

Portable pipe saw

PS 4.5 Plus

Properties, application area, technical specifications and delivery scope, see page 31.

ITEM	VERSION	CODE	MACHINE WEIGHT KG	SHIPPING WEIGHT KG
PS 4.5 Plus	230 V, 50/60 Hz EU	790 048 001	23.600	37.000
PS 4.5 Plus	110 V, 50/60 Hz EU	790 048 002	23.600	37.000
PS 4.5 Plus	120 V, 50/60 Hz US	790 048 003	23.600	37.000



PS 4.5 Plus

Quick-mounting plate with screw clamps

Simple and rapid mounting at workbenches without drilling.
Incl. 4 hexagon socket head screws for mounting the PS on the quick-mounting plate.

ITEM	CODE	KG
Quick-mounting plate with screw clamps	790 048 334	2.600



Quick-mounting plate with screw clamps

Saw blades

Performance series for high-alloyed steels (special steel).
Recommended saw blades (only Ø 63 mm/2.480") for the portable pipe saws PS 4.5 Plus.

ITEM	VERSION	PIPE WALL THICKNESS		SAW BLADE Ø		CODE	KG
		[MM]	[INCH]	[MM]	[INCH]		
Saw blade	Performance	1.0 - 3.0	0,039 - 0,118	63	2.480	790 048 072	0.035
Saw blade	Performance	0.6 - 1.2	0,024 - 0,047	63	2.480	790 041 036	0.027



Saw blade Performance



Tripod

Made of aluminum. Suitable for PS 4.5 Plus and GFX 3.0.
Simple mounting of the saws directly on the tripod without mounting plate.
Dismountable in a few steps. Storage in PS transport case possible. Space-saving - usable quickly - good handling

ITEM	CODE	KG
Tripod for PS 4.5 Plus, GFX 3.0	790 048 390	7.400

MRA

Metal pipe cutter

Cutting pipes in an instant.

The metal pipe cutter is especially suitable for cutting in tight spaces and for cutting processes which must not result in chips.

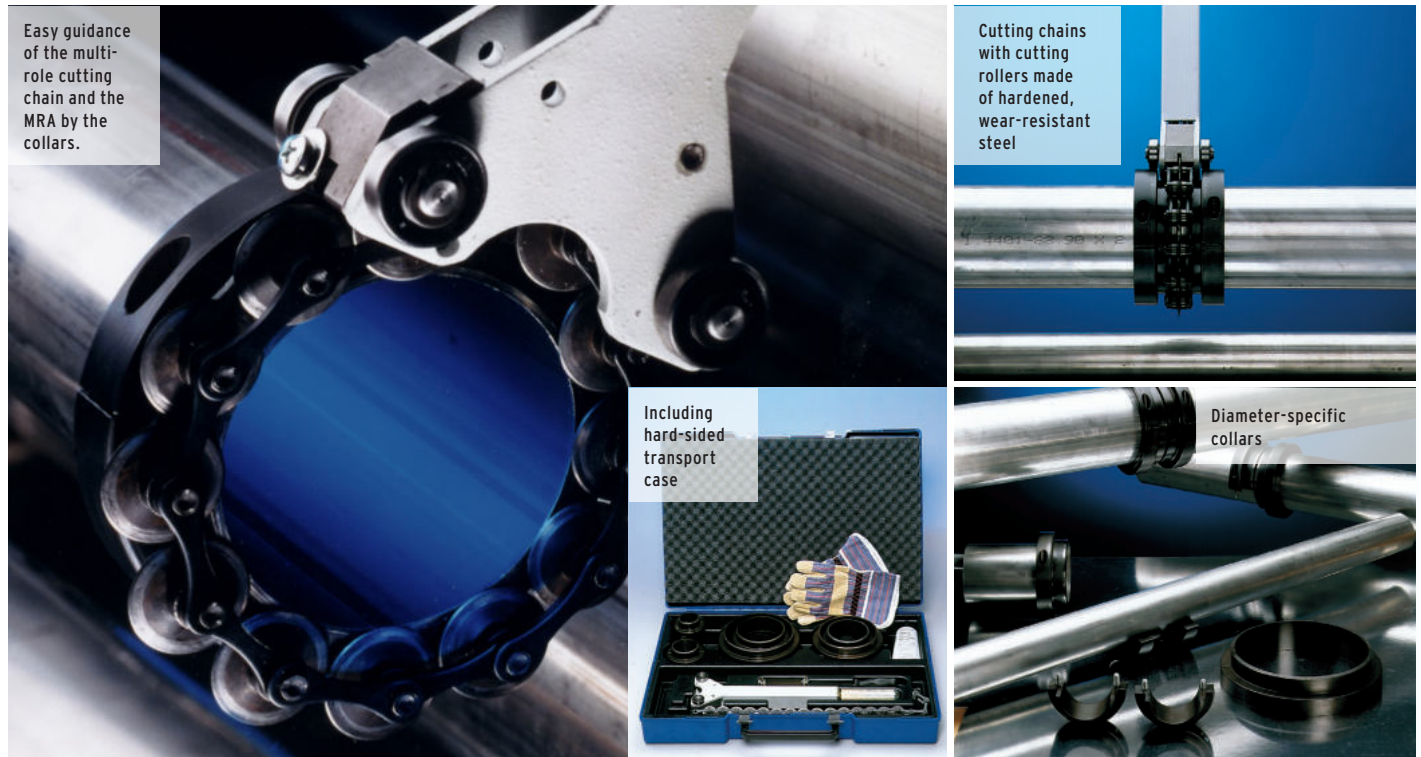

For manual cutting of metal pipes in any position. Easy to use - superior when it comes to safety.

The patented cutting technology of the MRA is based on diameter-specific collars and flexible multi-role cutting chains.

These two components manufactured from hardened, wear-resistant steel enable:

- High service life of the components
- Right-angled guidance of the cutting chain around the pipe
- Running of the MRA over rollers on the collars
- Low hand oscillations
- The cutting of pipes made of special steel stainless

ADDITIONAL ADVANTAGES:

- Deformation-free and right-angled
- Without current and bevel-free
- In the smallest space and in any position

CUTTABLE MATERIALS:

- High-alloyed steel (special steel stainless, material no. 1.40... to 1.45...)
- Unalloyed and low-alloyed steel
- Cast materials
- Non-ferrous metals

APPLICATION AREA		MRA
Code		790 008 001
Pipe OD	[mm] [inch]	25.0 - 254.0 0.984 - 10.000
Wall thickness*	[mm] [inch]	0.8 - 3.0 0,031 - 0,118
TECHNICAL SPECIFICATIONS		MRA
Dimensions	[mm] [inch]	450 x 105 17.7 x 4.1
SCOPE OF DELIVERY		MRA
Metal pipe cutter MRA	PCS.	1
Hard-sided transport case	PCS.	1
Hexagon key	PCS.	1
Connecting clamp	PCS.	1
Work gloves	Pair	1
Operating instructions and spare part list	Set	1

Technical specifications are non-binding. They do not constitute any assurance of properties. We reserve the right to make changes.

* Material-dependent. For high-alloyed steels the maximum wall thickness to be manufactured is 2.0 - 2.5mm (0.079 - 0.098")



MRA



MRA cutting chain



MRA collars

Metal pipe cutter

MRA

Properties, application area, technical specifications and delivery scope, see page 35.

Cutting chains and collars have to be ordered separately.

ITEM	CODE	MACHINE WEIGHT KG	SHIPPING WEIGHT KG
Metal pipe cutter MRA	790 008 001	3.100	8.000

MRA cutting chains

With cutting rollers made of hardened, wear-resistant steel.

ITEM	PIPE OD		CUTTING ROLLERS [PIECES]	CODE	KG
	[MM]	[INCH]			
MRA cutting chain	25.0 - 114.3	0.984 - 4.500	15	790 008 018	0.500
MRA cutting chain	114.3 - 254.0	4,500 - 10,000	16	790 008 041	0.900

MRA collars

In pairs, made of hardened steel. One collar pair is required per pipe dimension. Further collar dimensions on request.

PIPE OD		CODE	KG	PIPE OD		CODE	KG
[MM]	[INCH]			[MM]	[INCH]		
25.0	0.984	790 008 102	0.650	80.0	3.150	790 008 233	1.375
25.4	1.000	790 008 104	0.655	84.0	3.300	790 008 240	1.690
29.0	1.142	790 008 103	0.705	85.0	3.350	790 008 245	1.750
33.7	1.330	790 008 105	0.885	88.9	3.500	790 008 250	1.780
38.1	1.500	790 008 130	0.955	100.0	3.937	790 008 255	1.970
40.0	1.575	790 008 135	0.955	101.6	4.000	790 008 260	2.025
42.4	1.670	790 008 140	1.005	104.0	4.095	790 008 270	1.925
44.5	1.752	790 008 150	1.052	108.0	4.252	790 008 280	2.100
48.3	1.900	790 008 155	1.100	110.0	4.330	790 008 285	2.150
50.0	1.970	790 008 160	1.130	114.3	4.500	790 008 290	2.295
50.8	2.000	790 008 165	1.140	129.0	5.080	790 008 315	2.800
52.0	2.050	790 008 175	1.190	139.7	5.500	790 008 325	3.000
53.0	2.087	790 008 180	1.150	150.0	5.906	790 008 333	3.375
54.0	2.125	790 008 185	1.100	152.4	6.000	790 008 335	3.232
57.0	2.244	790 008 190	1.210	154.0	6.060	790 008 340	3.365
60.3	2.375	790 008 195	1.315	160.0	6.300	790 008 355	3.520
63.5	2.500	790 008 200	1.375	165.0	6.496	790 008 360	4.125
65.0	2.559	790 008 203	1.375	168.3	6.625	790 008 365	3.600
70.0	2.755	790 008 215	1.445	204.0	8.030	790 008 380	4.375
73.0	2.874	790 008 220	1.480	219.1	8.625	790 008 385	4.680
75.0	2.950	790 008 225	1.600	228.6	9.000	790 008 387	4.890
76.1	2.996	790 008 230	1.560	254.0	10.000	790 008 390	5.420

Other accessories

- Folding workbench, see page 80

PIPE CUTTING AND BEVELING TECHNOLOGY

Tube squaring technology

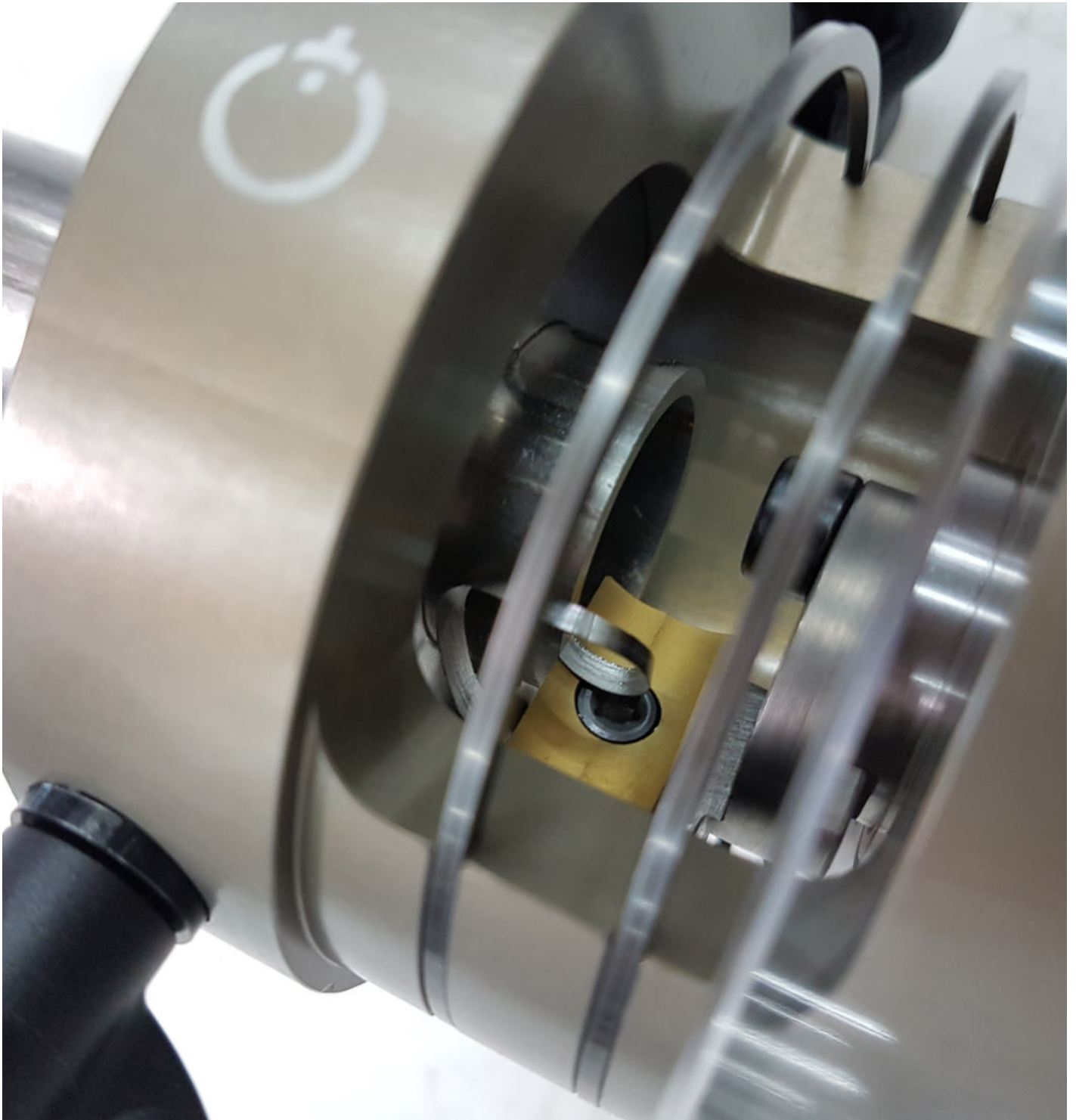

Comprehensive training program.

We attach great importance to the safe operation of our machines - this has the highest priority for us.

Therefore we recommend participation in a product training to learn correct and safe handling of our machines and avoid possible dangers and accidents already in advance.

If you would like to learn more about our comprehensive training program or would like information on upcoming dates for users, please contact our training team under the phone number:

+49 (0) 77 31 792-200

Or send us an e-mail to:

training@itw-ocw.com

RPG ONE, RPG 1.5

Tube squaring machines (electric/battery)

The RPG series stands for ease of use and particularly economical processing.

The domains of the RPG XS series include squaring (I-seam) thin-walled stainless steel pipes and micro-fittings, as well as unalloyed and low-alloyed steels, aluminum, titanium. The machines fit excellently in the hand and its size and weight can hardly be surpassed. Users can select the appropriate clamping collars from the range of accessories for each diameter.

For burr-free and right angled squaring and beveling of thin-walled stainless steel pipes and micro-fittings. The required, high-quality pipe end preparation, including for orbital welding!



Generates a tube squaring surface with very high surface finish	✓
Burr-free and right-angled	✓
Beveling possible with special holder (RPG 1.5 only)	✓
Quick change system for tools, clamping collars and pipes	✓
Machining of thin-walled stainless steel pipes (V4A) and micro-fittings	✓
Base plate with 2 cutting edges and high-performance coating	✓
Electric versions with speed controlled electric motor with speed stabilization	✓
Battery versions with powerful and environment-friendly lithium-ion technology	✓
Portable and light machine for mobile and safe use	✓

Pipe and installation manufacturers from the high-purity gas, electronics, pharmaceuticals, food processing, beverages, solar and chemical industries benefit from the mobile, high-quality and burr-free processing of pipe ends with our RPG series.

Tools, clamping shells and pipes can be replaced with the quick change system easily and without additional accessories.

All multifunctional tools (MFW) have 2 cutting edges and high-performance coating against wear. This way pipes made of unalloyed, low-alloyed and high-alloyed steel can be processed rapidly and economically with high precision.

In case of an extension or repair of an existing plant we offer the optimum, network-independent solution for tight spaces with the **battery variant**. The battery drive has been adapted to the requirements of the customer. The machine and accessories are supplied in a handy transport case, including a 230 V charger

for the European market or a 120 V charger for the American market.

ADDITIONAL ADVANTAGES:

- Feed with millimeter graduation for an optimum result
- No additional tools required for processing
- Modular design enables compatibility within the RPG series

ELECTRIC VERSIONS:

- Rotatable and removable drive
- Speed-controlled electric motor with speed stabilization
- Vario-Tacho-Constamatic (VTC) full-wave electronic control
- Inhibitor protection prevents an inadvertent startup of the machine after repeated power supply or in case of voltage recovery after power failure
- Adjustment wheel for speed selection
- Robust marathon motor

- Overload protection
- Cut-off carbon brushes
- Carbon wear display

BATTERY VERSIONS:

- Short overall length
- Lithium-ion technology
- Brushless motor with high performance and small size
- No memory effect
- Single cell monitoring in rechargeable battery pack
- Electronic overload protection with integrated temperature monitor
- Robust rechargeable battery packs with capacity indicator
- Low self-discharge
- Environmentally friendly
- AIR COOLED technology for short charging times and a long service life



Technical specifications are non-binding. They do not constitute any assurance of properties. We reserve the right to make changes.

APPLICATION AREA		RPG ONE	RPG ONE BATTERY	RPG 1.5	RPG 1.5 BATTERY
Code	[230 V]	790 036 031	790 036 021	790 037 001	790 037 011
	[115 V]	-	790 036 022	-	790 037 012
	[120 V]	790 036 032	-	790 037 002	-
	[110 V]	790 036 033	-	790 037 003	-
Pipe OD min. - max.	[mm]	3.0* - 25.4	3.0* - 25.4	3.0* - 38.1	3.0* - 38.1
	[inch]	0.118* - 1.0	0.118* - 1.0	0.118* - 1.5	0.118* - 1.5
Wall thickness max.	[mm]	2.0	2.0	3.0	3.0
	[inch]	0.079	0.079	0.118	0.118
Materials	High-alloyed steels (special steel material no. 1.40... - 1.45... according to DIN 17455 and DIN 17456), unalloyed and low-alloyed steel, aluminum.				
TECHNICAL SPECIFICATIONS		RPG ONE	RPG ONE BATTERY	RPG 1.5	RPG 1.5 BATTERY
Dimensions (LxDxH)	[mm]	390 x 70 x 200	261 x 80 x 255	400 x 160 x 350	275 x 90 x 255
	[inch]	15.4 x 2.8 x 7.9	10.3 x 3.2 x 10	15.8 x 6.3 x 13.8	10.8 x 3.5 x 10
Tool speed	[rpm]	145 - 380	0 - 500	145 - 380	0 - 500
Power	[W]	1100	-	1100	-
Exchangeable battery voltage	[V]	-	18	-	18
Capacity	[Ah]	-	4.0	-	4.0
Sound pressure level at the workplace (EN 23741)	[dB (A)]	Approx. 78	Approx. 78	Approx. 78	Approx. 78
Vibration level (EN 50144)	[m/s ²]	< 2.5	< 2.5	< 2.5	< 2.5
SCOPE OF DELIVERY		RPG ONE	RPG ONE BATTERY	RPG 1.5	RPG 1.5 BATTERY
Tube squaring machine	PCS.	1	1	1	1
Transport case	PCS.	1	1	1	1
Exchangeable batteries	PCS.	-	2	-	2
Charger	PCS.	-	1	-	1
Overload fuse (square nut)	PCS.	-	-	-	-
Tool holder WH (Code 790 ...)	PCS.	1 (... 037 152)	1 (... 037 152)	1 (... 037 152)	1 (... 037 152)
Multifunctional tool MFW (Code 790 038 314)	PCS.	1	1	1	1
Tool key	Set	1	1	1	1
Operating instructions and spare part list	Set	1	1	1	1
Base plate for battery machines is optionally available on request (Code 790 037 169)					

* Field of application with standard tool holder (Code 790 037 152) as of 6.0mm/0.236" possible. With special tool holder (Code 790 037 161) as of 3.0mm/0.118".



RPG ONE



RPG 1.5



RPG ONE battery



RPG 1.5 battery

Tube squaring machines

RPG ONE, RPG 1.5

Properties, application area, technical specifications and delivery scope, see page 39.

Special-steel clamping collars have to be ordered separately.

ITEM	VERSION	CODE	MACHINE WEIGHT KG	SHIPPING WEIGHT KG
RPG ONE	230 V, 50/60 Hz EU	790 036 031	4.140	9.600
RPG ONE	120 V, 50/60 Hz US	790 036 032	4.140	9.600
RPG ONE	110 V, 50/60 Hz EU	790 036 033	4.140	9.600
RPG ONE battery (18 V)	230 V, 50/60 Hz EU	790 036 021	2.880	8.200
RPG ONE battery (18 V)	115 V, 60 Hz US	790 036 022	2.880	8.200
RPG 1.5	230 V, 50/60 Hz EU	790 037 001	4.700	9.500
RPG 1.5	120 V, 50/60 Hz US	790 037 002	4.700	9.500
RPG 1.5	110 V, 50/60 Hz EU	790 037 003	4.700	9.500
RPG 1.5 battery (18 V)	230 V, 50/60 Hz EU	790 037 011	3.440	10.100
RPG 1.5 battery (18 V)	115 V, 60 Hz US	790 037 012	3.440	10.100



RPG ONE / RPG ONE battery



RPG 1.5 / RPG 1.5 battery

Angle drive for RPG ONE (battery) and RPG 1.5 (battery)

The angle drive is available optionally and can be mounted subsequently on the following RPG machines:

RPG ONE; RPG ONE battery; RPG 1.5; RPG 1.5 battery

The angle drive can be used to reduce the overall length to 200 mm (7.874"). The technical specifications remain unchanged.

ITEM	CODE	KG
Angle drive for RPG ONE and RPG 1.5 (battery)	790 037 400	0.475



Angle drive

Special-steel clamping collars

Extremely resistant. Ensure a precise clamping of pipes and micro-fittings and a rapid clamping collar change without tools through a unique design with forcibly actuated clamping shell mechanism. Further clamping collar dimensions are available.

Please check the outer diameter of the pipes before ordering the clamping collars.

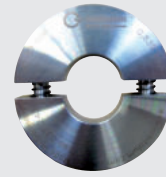

Stainless-steel clamping collar
For pipes

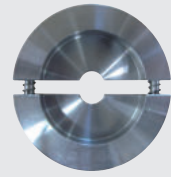

Stainless-steel clamping collar
For micro-fittings

Machine model:	Clamping length for pipes:	Clamping length for micro-fittings:
RPG ONE	10.0 mm (0.394")	4.0 mm (0.157")
RPG 1.5	15.0 mm (0.591")	4.0 mm (0.157")

MACHINE TYPE		RPG ONE				RPG 1.5			
PIPE OD		PIPES		MICRO-FITTINGS		PIPES		MICRO-FITTINGS	
[MM]	[INCH]	790...	KG	790...	KG	790...	KG	790...	KG
3.00	0.118	036 232	0.118	-	-	037 220	0,300	037 300	0.225
3.18	0.125	036 201	0.119	-	-	037 221	0,308	037 301	0.227
4.00	0.157	-	-	-	-	037 222	0,310	037 302	0.226
4.78	0.188	-	-	-	-	037 223	0,310	037 303	0.234
5.00	0.197	-	-	-	-	037 224	0,308	037 304	0.228
6.00	0.236	036 213	0.117	036 304	0.066	037 225	0,310	037 305	0.220
6.35	0.250	036 202	0.118	036 301	0.066	037 226	0,306	037 306	0.460
7.00	0.276	036 214	0.118	-	-	037 257	0,306	-	-
8.00	0.315	036 215	0.118	036 307	0.065	037 227	0,299	037 307	0.223
9.00	0.354	-	-	-	-	037 254	0,280	-	-
9.53	0.375	036 203	0.115	036 302	0.064	037 228	0,297	037 308	0.300
10.00	0.394	036 204	0.115	036 305	0.065	037 229	0,298	037 309	0.222
10.10	0.398	036 222	0.114	-	-	-	-	-	-
11.00	0.433	036 226	0.112	-	-	037 293	0,252	-	-
11.11	0.437	-	-	-	-	037 255	0,295	-	-
12.00	0.472	036 205	0.112	036 306	0.064	037 230	0,293	037 310	0.220
12.10	0.476	036 223	0.111	-	-	-	-	-	-
12.50	0.492	-	-	-	-	-	-	037 317	0.220
12.70	0.500	036 206	0.111	036 303	0.062	037 231	0,292	037 311	0.220
13.00	0.512	-	-	-	-	037 232	0,295	-	-
13.20	0.520	-	-	-	-	037 263	0,290	-	-
13.50	0.531	036 227	0.110	-	-	037 233	0,290	-	-
14.00	0.551	036 228	0.108	-	-	037 234	0,288	-	-
14.10	0.555	036 224	0.107	-	-	-	-	-	-
14.30	0.563	-	-	-	-	037 253	0,289	-	-
14.70	0.579	-	-	-	-	037 290	0,287	-	-
15.00	0.591	036 216	0.107	-	-	037 235	0,287	-	-
15.30	0.602	-	-	-	-	037 259	0,287	-	-
15.60	0.614	036 225	0.105	-	-	-	-	-	-
15.70	0.618	-	-	-	-	037 291	0,284	-	-
15.88	0.625	036 211	0.105	-	-	037 236	0,285	-	-
16.00	0.630	036 212	0.104	-	-	037 237	0,285	-	-
17.00	0.670	036 221	0.103	-	-	037 256	0,280	-	-
17.08	0.672	-	-	-	-	037 260	0,281	-	-
17.20	0.677	036 207	0.104	-	-	037 238	0,300	037 312	0.220
18.00	0.709	036 217	0.102	-	-	037 239	0,280	-	-
19.00	0.748	-	-	-	-	037 240	0,275	037 314	0.216
19.05	0.750	036 208	0.100	-	-	037 241	0,274	037 315	0.215
20.00	0.787	036 230	0.096	-	-	037 242	0,272	-	-
21.00	0.827	-	-	-	-	037 294	0,270	-	-
21.20	0.835	-	-	-	-	-	-	037 313	0.213
21.30	0.839	036 209	0.094	036 317	0.057	037 243	0,270	037 318	0.212
21.70	0.854	036 220	0.093	-	-	037 261	0,270	-	-
22.00	0.866	036 218	0.093	-	-	037 244	0,264	-	-
22.22	0.875	-	-	-	-	037 292	0,270	-	-
23.00	0.906	036 219	0.085	-	-	037 245	0,255	-	-
24.00	0.945	-	-	-	-	037 246	0,256	-	-
25.00	0.984	036 231	0.081	-	-	037 247	0,252	-	-
25.40	1.000	036 210	0.083	-	-	037 248	0,240	-	-

TUBE SQUARING TECHNOLOGY

MACHINE TYPE		RPG ONE				RPG 1.5			
PIPE OD		PIPES		MICRO-FITTINGS		PIPES		MICRO-FITTINGS	
[MM]	[INCH]	790...	KG	790...	KG	790...	KG	790...	KG
26.90	1.059	-	-	-	-	037 249	0,260	-	-
27.00	1.063	-	-	-	-	037 264	0,260	-	-
27.20	1.071	-	-	-	-	037 262	0,260	-	-
28.00	1.102	-	-	-	-	037 250	0,240	-	-
29.00	1.142	-	-	-	-	037 251	0,232	-	-
30.00	1.181	-	-	-	-	037 252	0,228	-	-
31.80	1.250	-	-	-	-	037 280	0,230	-	-
32.00	1.260	-	-	-	-	037 258	0,226	-	-
33.40	1.315	-	-	-	-	037 281	0,220	-	-
33.70	1.327	-	-	-	-	037 282	0,218	-	-
34.00	1.339	-	-	-	-	037 283	0,215	-	-
35.00	1.377	-	-	-	-	037 284	0,210	-	-
36.00	1.417	-	-	-	-	037 285	0,204	-	-
38.00	1.496	-	-	-	-	037 286	0,199	-	-
38.10	1.500	-	-	-	-	037 287	0,194	-	-



Tool holder WH

Tool holder WH

Suitable for MFW 790 038 314. Incl. Torx fastening screw M4x10 (790 086 220).
For max. wall thickness 3 mm

Application area Tool holder	Machine method		Beveling angle [°]		Pipe OD	
	Squaring	Beveling			RPG ONE (battery)	RPG 1.5 (battery)
WH12-1/Standard* Code 790 037 152	x	-	-	[mm] 6.0 - 25.4 [inch] 0,236 - 1.0	6.0 - 38.1 0,236 - 1.5	
WH12-1 Code 790 037 161	x	-	-	[mm] 3.0 - 6.0 [inch] 0,118 - 0,236	3.0 - 6.0 0,118 - 0,236	
WH12-1/Micro-fittings** Code 790 037 156	x	-	-	[mm] - [inch] -	3.0 - 21.2 0,118 - 0.84	
WH3-V-30*** Code 790 037 158	-	x	30°	[mm] - [inch] -	max. 35.0 max. 1,378	
WH3-V-35*** Code 790 037 159	-	x	35°	[mm] - [inch] -	max. 33.7 max. 1,327	
WH3-V-45*** Code 790 037 157	-	x	45°	[mm] - [inch] -	max. 33.7 max. 1,327	

ITEM	CODE	KG
Standard tool holder WH12-1*	790 037 152	0.040
Special tool holder WH12-1	790 037 161	0.026
Special tool holder micro-fittings WH12-1**	790 037 156	0.100
Tool holder WH3-V-30	790 037 158	0.024
Tool holder WH3-V-35	790 037 159	0.024
Tool holder WH3-V-45***	790 037 157	0.022

* Included in the standard scope of delivery.

** Only to be used with special steel clamping collars for micro-fittings.

*** Cannot be used with the RPG ONE.



Multifunctional tool MFW

Multifunctional tool MFW

With 2 cutting edges and process-specific tool wear protective coating.
Can be used with all the machines of the RPG series.

ITEM	QUANTITY	CODE	KG
Multifunctional tool MFW-P-2	1	790 038 314	0.003
Multifunctional tool MFW-P-2	10	790 038 315	0.045
Torx screw	1	790 086 220	0.002

Other accessories

- Folding workbench, see page 80

RPG 3.0 (battery), RPG 4.5 (S), RPG 8.6

Tube squaring machines

In manual welding technology a high quality pipe end processing is desirable for economical reasons. In automated welding, also called "orbital welding", the high quality of pipe end processing is required for technical reasons. For this weld seam preparation Orbitalum has developed the tube squaring machines RPG 3.0 (battery), RPG 4.5, RPG 4.5 S and RPG 8.6. The optimum solution for the required, high quality pipe end preparation for orbital welding.



Generates a tube squaring surface with very high surface finish	✓
Burr-free and right-angled	✓
Beveling possible with special holder (not with RPG 4.5 S)	✓
Quick change system for tools, clamping collars and pipes	✓
Machining of thin-walled stainless steel pipes (V4A)	✓
Base plate with 2 cutting edges and high-performance coating	✓
Speed-controlled electric motor	✓
Feed with millimeter graduation for an optimum result	✓
Portable and light machine for mobile and safe use	✓

With the RPG 3.0 (battery) the user can machine pipes with an outer diameter of 6.0 mm - 77.0 mm with high precision. The RPG 4.5 can machine pipe ends rapidly, burr-free and absolutely right-angled up to 114.4 mm (4.5") and the RPG 8.6 up to 219.1 mm (8.6").

Low operating costs are a huge advantage when processing pipes. The symmetrical, exchangeable special steel and aluminum clamping collars (not for RPG 4.5 S) can be easily and rapidly exchanged in a short amount of time and without tools. A dimension exchange does not require much more time. Thanks to the ergonomic machine design the user can work in a convenient and time-saving manner.

The multifunctional tools (MFW)

have 2 cutting edges and a high-performance coating against wear. This way pipes made of unalloyed, low-alloyed and high-alloyed steel can be processed rapidly and economically with high precision. The system enables clean and safe working.

The RPG 3.0, RPG 4.5 (S) and RPG 8.6 is equipped with a high-quality powerful drive in 230 volt and 120 volt versions.

The RPG 3.0 is also available as battery versions (230 V or 115 V), with powerful and environmentally-friendly lithium-ion technology. Machine and accessories are supplied in a robust hard-sided transport case.

ADDITIONAL SPECIFICATIONS OF THE RPG 4.5 S:

The tube squaring machine **RPG 4.5 S** is characterized by its universal vice-clamping system: With this special economical alternative to other conventional dimension-specific clamping collars, pipes can be clamped and processed in the easiest way possible.

- Integrated clamping jaws made of annealed cast aluminum for different pipe diameters
- High cost effectiveness, since no dimension-specific clamping collars required
- Multipoint clamping of the pipe



Delivery in hard-sided transport case

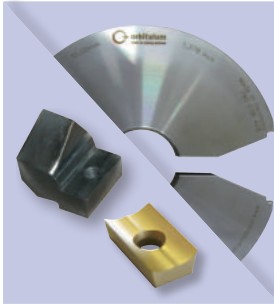

Including tool holder WH and multi-functional tool MFW. Large selection of clamping collars is available –separately.

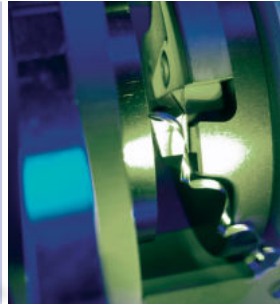

Burr-free and right-angled

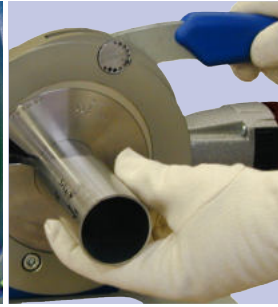

Quick change system for tools, clamping collars and pipes



Application: Pipe and plant manufacturers for high-purity gas, electronics, pharmaceuticals, food processing, beverages, solar as well as chemical industries

APPLICATION AREA		RPG 3.0	RPG3.0 AKKU	RPG 4.5	RPG 4.5 S	RPG 8.6
Code	[230 V]	790 031 001	790 031 011	790 038 001	790 038 011	790 039 001
	[110 V]	790 031 003	-	790 038 003	-	790 039 003
	[120 V]	790 031 002	-	790 038 002	790 038 012	790 039 002
	[115 V]	-	790 031 012	-	-	-
Pipe OD	[mm]	6.0 - 77.0	6.0 - 77.0	12.7 - 114.3	12.7 - 114.3	50.8 - 219.1
	[inch]	0.24 - 3.0	0.24 - 3.0	0.5 - 4.5	0.5 - 4.5	2 - 8.6
Wall thickness max.	[mm]	3.0	3.0	3.0	3.0	3.6
	[inch]	0.118	0.118	0.118	0.118	0.142
Materials		High-alloyed steels (special steel material no. 1.40... - 1.45... according to DIN 17 455 and DIN 17 456), unalloyed and low-alloyed steels, aluminum. Others on request.				
TECHNICAL SPECIFICATIONS		RPG 3.0	RPG3.0 AKKU	RPG 4.5	RPG 4.5 S	RPG 8.6
Dimensions (with drive)	[mm]	460 x 245 x 185	325 x 245 x 185	460 x 260 x 230	610 x 380 x 270	500 x 350 x 350
	[inch]	18.1 x 9.6 x 7.3	12.8 x 9.6 x 7.3	18.1 x 10.2 x 9.1	24 x 15 x 10.6	19.7 x 13.8 x 13.8
Power	[W]	1100	-	1100	1100	1100
Protection class	[Class]	II	II (charger)	II	II	II
Speed (max. idle speed)	[min ⁻¹]	8 - 52	0-30 (1st gear)	8 - 52	8 - 52	7 - 18
Vibration level (EN 60745)	[m/s ²]	< 2.5	< 2.5	< 2.5	< 2.5	< 2.5
Sound pressure level at the workplace (EN 23741)	[dB (A)]	During idling approx. 83	During idling approx. 83	During idling approx. 83	During idling approx. 83	During idling approx. 83
SCOPE OF DELIVERY		RPG3.0	RPG3.0 AKKU	RPG 4.5	RPG 4.5 S	RPG 8.6
Tube squaring machine	PCS.	1	1	1	1	1
Hard-sided transport case	PCS.	1	1	1	1	1
Tool holder WH (Code 790 038 320)	PCS.	1	1	1	1	1
Overload protection (square nut)	PCS.	1	1	1	1	1
Multifunctional tool MFW (Code 790 038 314)	PCS.	1	1	1	1	1
Tool key	Set	1	1	1	1	1
Operating instructions and spare part list	Set	1	1	1	1	1

Technical specifications are non-binding. They do not constitute any assurance of properties. We reserve the right to make changes.



RPG 4.5

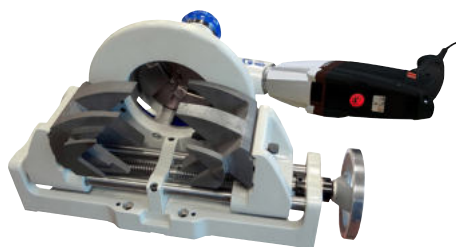

RPG 4.5 S



RPG 8.6



RPG 3.0



RPG 3.0 battery

Tube squaring machines

RPG 3.0 (battery), RPG 4.5, RPG 4.5 S, RPG 8.6

Properties, application area, technical specifications and delivery scope, see page 45.

Clamping collars have to be ordered separately.

ITEM	VERSION	CODE	MACHINE WEIGHT KG	SHIPPING WEIGHT KG
RPG 3.0	230 V, 50/60 Hz EU	790 031 001	7.800	16.300
RPG 3.0	110 V, 50/60 Hz EU	790 031 003	7.800	16.300
RPG 3.0	120 V, 50/60 Hz US	790 031 002	7.800	16.300
RPG 3.0 battery	(18 V), 230 V, 50/60 Hz EU	790 031 011	7.100	16.800
RPG 3.0 battery	(18 V), 115 V, 50/60 Hz US	790 031 012	7.100	16.800
RPG 4.5	230 V, 50/60 Hz EU	790 038 001	10.500	19.400
RPG 4.5	110 V, 50/60 Hz EU	790 038 003	10.500	19.400
RPG 4.5	120 V, 50/60 Hz US	790 038 002	10.500	19.400
RPG 4.5 S	230 V, 50/60 Hz EU	790 038 011	23.000	34.000
RPG 4.5 S	120 V, 50/60 Hz US	790 038 012	23.000	34.000
RPG 8.6	230 V, 50/60 Hz EU	790 039 001	20.500	32.000
RPG 8.6	110 V, 50/60 Hz EU	790 039 003	20.500	32.000
RPG 8.6	120 V, 50/60 Hz US	790 039 002	20.500	32.000



RPG 4.5

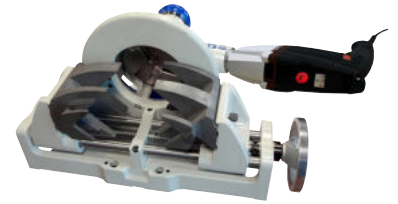

RPG 4.5 S



RPG 8.6

TUBE SQUARING TECHNOLOGY

Clamping collars

Extremely resistant. The clamping collar with click mechanism guarantees precise clamping of pipes and rapid clamping collar change without tools. Further clamping collar dimensions are available.

Please check the outer diameter of the pipes before ordering the clamping collars.

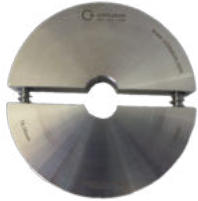

Special-steel clamping collar for RPG 3.0 (battery)

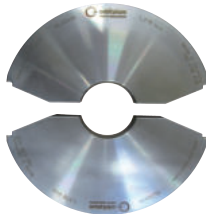

Special-steel clamping collar for RPG 4.5



Aluminum clamping collar for RPG 8.6

Machine model:	Clamping lengths:
RPG 3.0	19.9 mm (0.783")
RPG 4.5	24.9 mm (0.980")
RPG 8.6	39.9 mm (1.571")

CAN BE USED WITH:		RPG 3.0 (BATTERY)		RPG 4.5		RPG 8.6	
PIPE OD		STAINLESS STEEL		STAINLESS STEEL		ALUMINUM	
[MM]	[INCH]	CODE	KG	CODE	KG	CODE	KG
6.35	0.25	790 031 239	-	-	-	-	-
10.00	0.394	790 031 243	1.300	-	-	-	-
12.00	0.472	790 031 244	1.300	790 038 454	2.170	-	-
12.70	0.500	790 031 232	1.245	790 038 438	2.177	-	-
13.00	0.512	-	-	790 038 439	2.176	-	-
13.50	0.531	-	-	790 038 440	2.175	-	-
14.00	0.551	-	-	790 038 441	2.174	-	-
16.00	0.630	-	-	790 038 442	2.168	-	-
17.20	0.677	-	-	790 038 443	2.164	-	-
18.00	0.709	-	-	790 038 444	2.161	-	-
19.00	0.748	-	-	790 038 445	2.150	-	-
19.05	0.750	790 031 233	1.225	790 038 446	2.157	-	-
20.00	0.787	-	-	790 038 447	2.153	-	-
21.30	0.839	790 031 245	1.200	790 038 448	2.100	-	-
22.00	0.866	-	-	790 038 449	2.144	-	-
22.22	0.875	-	-	790 038 050	2.195	-	-
23.00	0.906	-	-	790 038 450	2.140	-	-
24.00	0.945	-	-	790 038 451	2.133	-	-
25.00	0.984	790 031 231	-	790 038 452	2.127	-	-
25.25	0.994	-	-	790 038 049	2.180	-	-
25.40	1.000	790 031 234	1.195	790 038 051	2.180	-	-
26.90	1.059	790 031 236	-	790 038 400	2.090	-	-
27.20	1.071	-	-	790 038 468	2.165	-	-
28.00	1.102	-	-	790 038 401	2.110	-	-
29.00	1.142	-	-	790 038 402	2.105	-	-
30.00	1.181	-	-	790 038 403	2.095	-	-
31.75	1.250	790 031 241	1.200	790 038 052	1.865	-	-
31.80	1.250	-	-	790 038 404	2.080	-	-
32.00	1.260	-	-	790 038 455	2.080	-	-
33.00	1.299	-	-	790 038 465	2.120	-	-
33.40	1.315	-	-	790 038 405	2.040	-	-
33.70	1.327	790 031 247	-	790 038 406	2.060	-	-
34.00	1.339	-	-	790 038 407	2.115	-	-
35.00	1.377	-	-	790 038 408	2.050	-	-
36.00	1.417	-	-	790 038 409	2.044	-	-
38.00	1.496	790 031 250	-	790 038 410	2.025	-	-
38.10	1.500	790 031 225	1.2	790 038 053	2.020	-	-
40.00	1.575	-	-	790 038 411	2.000	-	-
41.00	1.614	790 031 220	1.16	790 038 412	1.990	-	-
42.00	1.654	-	-	790 038 413	1.976	-	-
42.16	1.660	-	-	790 038 414	1.950	-	-
42.40	1.669	790 031 221	1.1	790 038 415	1.965	-	-
42.70	1.681	-	-	790 038 416	1.950	-	-
44.45	1.750	-	-	790 038 417	1.955	-	-
44.50	1.752	790 031 229	1.045	790 038 418	1.955	-	-
45.00	1.772	-	-	790 038 419	1.948	-	-
48.00	1.890	-	-	790 038 464	1.960	-	-
48.26	1.900	-	-	790 038 420	1.880	-	-
48.30	1.902	790 031 222	1.1	790 038 421	1.905	-	-
48.60	1.913	-	-	790 038 422	1.875	-	-

TUBE SQUARING TECHNOLOGY

CAN BE USED WITH:		RPG 3.0 (BATTERY)		RPG 4.5		RPG 8.6	
PIPE OD		STAINLESS STEEL		STAINLESS STEEL		ALUMINUM	
[MM]	[INCH]	CODE	KG	CODE	KG	CODE	KG
50.00	1.969	790 031 251	-	790 038 456	1.880	-	-
50.80	2.000	790 031 223	1.1	790 038 054	1.895	790 039 260	4.500
51.00	2.008	790 031 248	-	790 038 423	1.870	-	-
52.00	2.047	-	-	790 038 424	1.850	-	-
53.00	2.087	790 031 224	1.0	790 038 425	1.835	-	-
54.00	2.126	-	-	790 038 426	1.827	-	-
57.00	2.244	790 031 228	0.910	790 038 457	1.780	790 039 265	4.000
60.00	2.362	790 031 230	0.895	790 038 469	1.780	-	-
60.30	2.374	-	-	790 038 427	1.700	-	-
60.45	2.380	790 031 227	0.850	790 038 428	1.726	-	-
60.50	2.382	-	-	790 038 429	1.695	-	-
63.00	2.480	-	-	790 038 461	1.725	-	-
63.50	2.500	-	-	790 038 055	1.670	-	-
65.00	2.559	790 031 226	0.805	790 038 463	1.700	-	-
70.00	2.756	-	-	790 038 430	1.545	-	-
73.03	2.875	790 031 237	0.700	790 038 453	1.460	-	-
73.15	2.880	-	-	790 038 431	1.482	-	-
75.00	2.953	-	-	790 038 462	1.490	-	-
76.10	2.996	-	-	790 038 432	1.420	-	-
76.20	3.000	790 031 238	0.590	790 038 056	1.420	790 039 261	4.200
76.30	3.004	790 031 236	0.600	790 038 433	1.390	-	-
80.00	3.150	-	-	790 038 466	1.390	790 039 308	-
85.00	3.346	-	-	790 038 434	1.220	-	-
85.90	3.382	-	-	790 038 435	1.124	-	-
88.90	3.500	-	-	790 038 057	1.130	790 039 264	4.000
89.10	3.508	-	-	790 038 436	1.100	-	-
90.00	3.543	-	-	790 038 467	1.150	-	-
101.60	4.000	-	-	790 038 058	0.800	790 039 252	3.800
104.00	4.094	-	-	790 038 437	0.740	790 039 309	2.500
108.00	4.252	-	-	790 038 458	0.620	790 039 266	3.750
114.30	4.500	-	-	790 038 059	0.435	790 039 256	3.500
127.05	5.002	-	-	-	-	790 039 262	3.420
133.00	5.236	-	-	-	-	790 039 267	2.980
139.70	5.500	-	-	-	-	790 039 259	3.100
141.30	5.563	-	-	-	-	790 039 257	2.900
152.40	6.000	-	-	-	-	790 039 253	2.700
159.00	6.260	-	-	-	-	790 039 268	2.500
168.30	6.625	-	-	-	-	790 039 254	2.300
193.70	7.626	-	-	-	-	790 039 269	3.500
197.00	7.756	-	-	-	-	790 039 263	1.530
203.20	8.000	-	-	-	-	790 039 258	1.350
219.10	8.625	-	-	-	-	790 039 255	0.600

TUBE SQUARING TECHNOLOGY



Tool holder WH

Tool holder WH

Fitting for multifunctional tool 790 038 314.
Incl. Torx fastening screw M4x10 (790 086 220).

Beveling with the RPG 4.5 S is not recommended.

Application area Tool holder	Machine method		Beveling angle [°]
	Squaring	Beveling	
Tool holder WH12-I	x	-	-
Tool holder WH12-V-30°	-	x	30
Tool holder WH12-V-35°	-	x	35
Tool holder WH12-V-45°	-	x	45
Tool holder WH12-U-20°	-	x	20

ITEM	CODE	KG
Tool holder WH12-I	790 038 320	0.025
Tool holder WH12-V-30°	790 038 329	0.034
Tool holder WH12-V-35°	790 038 282	0.054
Tool holder WH12-V-45°	790 038 280	0.044
Tool holder WH12-U-20°	790 038 326	0.031

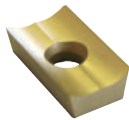

Multifunctional tool MFW

Multifunctional tool MFW

With 2 cutting edges and process-specific tool wear protective coating.
Can be used with all the machines of the RPG series.

ITEM	QUAN- TITY	CODE	KG
Multifunctional tool MFW-P-2	1	790 038 314	0.003
Multifunctional tool MFW-P-2	10	790 038 315	0.045

Other accessories

- Folding workbench, see page 80

Pipe beveling technology

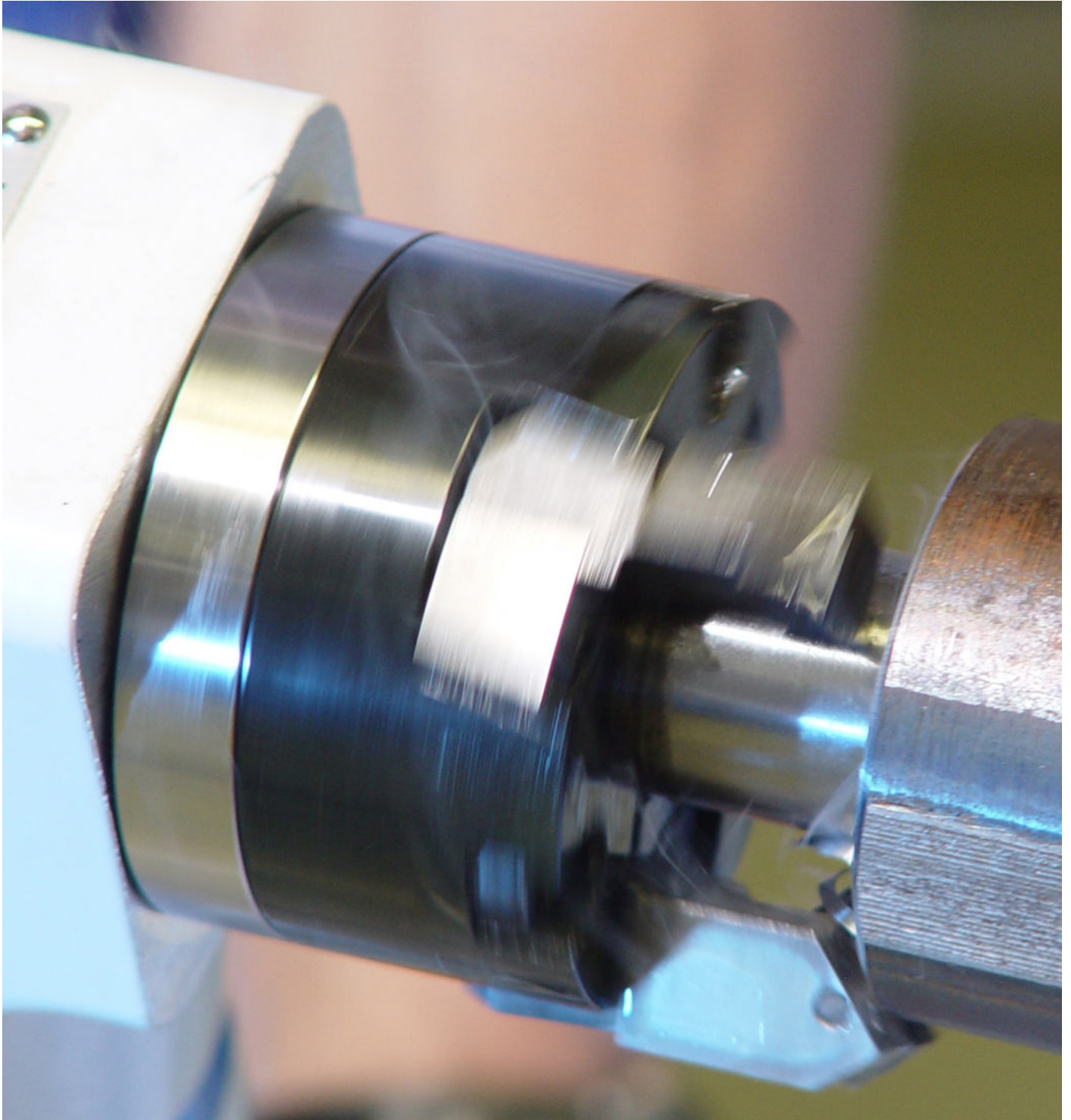

The right tool for your individual requirement

We are happy to help you with finding the fitting tool for your specific application. For this purpose, we require the following specifications to be able to offer you the relevant tool holders and multifunctional tools for our BRB and REB machines.

Please let us know for your request about the following dimensions (to the extent known):

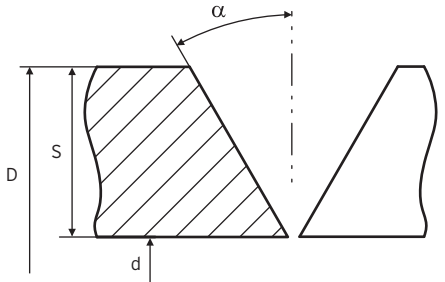
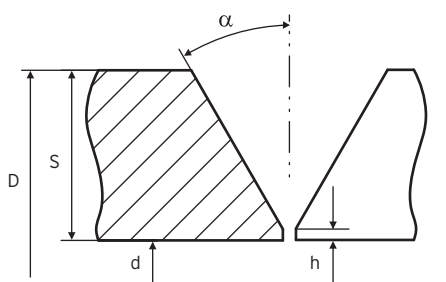
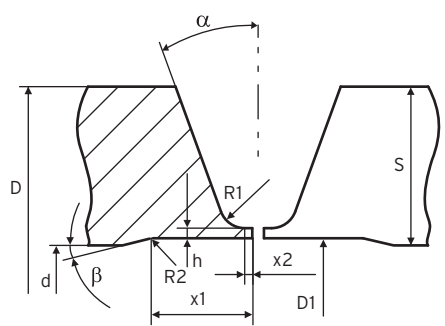
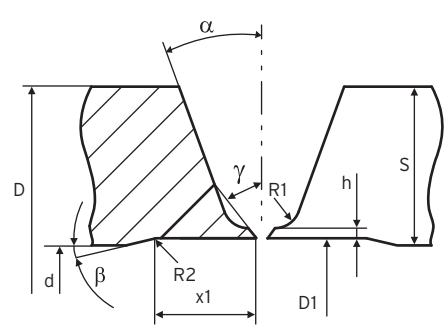
<p>V-seam</p> 	<table border="1"> <tr><td>D:</td></tr> <tr><td>d:</td></tr> <tr><td>S:</td></tr> <tr><td>α:</td></tr> </table>	D:	d:	S:	α :	<p>Y-seam</p> 	<table border="1"> <tr><td>D:</td></tr> <tr><td>d:</td></tr> <tr><td>S:</td></tr> <tr><td>h:</td></tr> <tr><td>α:</td></tr> </table>	D:	d:	S:	h:	α :													
D:																									
d:																									
S:																									
α :																									
D:																									
d:																									
S:																									
h:																									
α :																									
<p>U-seam (1)</p> 	<table border="1"> <tr><td>D:</td></tr> <tr><td>d:</td></tr> <tr><td>S:</td></tr> <tr><td>h:</td></tr> <tr><td>R1:</td></tr> <tr><td>R2:</td></tr> <tr><td>x1:</td></tr> <tr><td>x2:</td></tr> <tr><td>α:</td></tr> <tr><td>β:</td></tr> <tr><td>D1:</td></tr> </table>	D:	d:	S:	h:	R1:	R2:	x1:	x2:	α :	β :	D1:	<p>U-seam (2)</p> 	<table border="1"> <tr><td>D:</td></tr> <tr><td>d:</td></tr> <tr><td>S:</td></tr> <tr><td>h:</td></tr> <tr><td>R1:</td></tr> <tr><td>R2:</td></tr> <tr><td>x1:</td></tr> <tr><td>α:</td></tr> <tr><td>β:</td></tr> <tr><td>γ:</td></tr> <tr><td>D1:</td></tr> </table>	D:	d:	S:	h:	R1:	R2:	x1:	α :	β :	γ :	D1:
D:																									
d:																									
S:																									
h:																									
R1:																									
R2:																									
x1:																									
x2:																									
α :																									
β :																									
D1:																									
D:																									
d:																									
S:																									
h:																									
R1:																									
R2:																									
x1:																									
α :																									
β :																									
γ :																									
D1:																									

Your contact information:

Company:		
Customer No.:	Date:	Contact partner:
Phone:	Fax:	
Address:	Signature and company stamp:	
Remarks:		

Please send the filled form by **fax to +49 (0) 77 31 792-524** or email to **tools@orbitalum.com**.

BRB 4

Boiler pipe preparation machines

The solution for tight spaces!

Often only limited space is available for processing between welded boiler pipes. The compact and application-optimized housing design of our BRB machines allows the operator optimized handling in every position and is thus the solution for optimized seam preparation of pipe and pipe sheet connections in boiler and apparatus construction.

Manufacturing of I-/V-/Y- and U-seam joint forms and pipe ends made of high-alloyed steel (special steel) as well as low-alloyed and unalloyed steel with the innovate tool system QTC®.



Handy, ergonomic, compact design	✓
Precise and reproducible weld seam preparation	✓
Maximum power with low weight	✓
High-performance coated tool bits with up to 4 cutting edges	✓
Tool clamping system with simple, convenient adjustment	✓
Simple tool change; up to 3 tools can be used simultaneously	✓
Tools adaptable to all BRB machines	✓

The power pack in boiler pipe processing! The BRB series by Orbitalum, developed for boiler applications with very narrow space requirements, allows for precise welding preparations with optimum torque and simultaneously low weight.

With the quick tool change (QTC®) patented by Orbitalum Tools the tool can be changed quickly and easily. All multifunctional tools (MFW) have up to 4 cutting edges and a high-performance coating against wear. This way pipe ends made of unalloyed, low-alloyed and high-alloyed steel with chromium-nickel content can be machined particularly quickly and economically with high precision.

Machine and accessories are supplied in a robust hard-sided transport case.

THE VARIOUS CLAMPING SYSTEMS:

The "NC" clamping system with its clamping wedges anchored in the mast is ideal for applications in which foreign objects may not enter the pipe inside or a tank. The "NC" clamping system provides additional certainty in particular at vertical applications.

DRIVE VERSIONS:

Electric:

230 V, 50/60 Hz

Single-phase alternating current motor, protection class II, speed regulation.

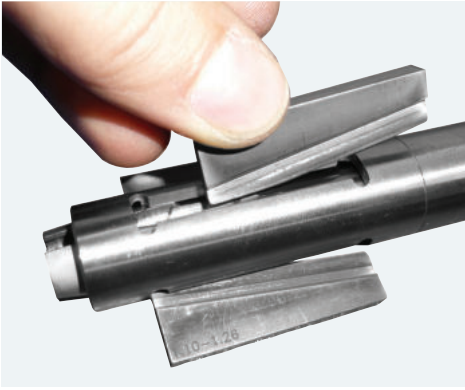

The "NC" clamping system cannot be lost thanks to its clamping wedges anchored in the mast



BRB 4 electrical with clamping system "NC", Kit 1



BRB 4 electrical with clamping system "NC", Kit 3

TECHNICAL SPECIFICATIONS		BRB 4
Drive version		Electric
Power	[kW]	1.2
Speed	[rpm]	12 - 37
Air consumption (for 6 bar)	[m ³ /min]	-
Sound pressure level Laeq 1m (EN 23741), approx.	[dB (A)]	82
Vibration level (EN 28662, Part 1)	[m/s ²]	2.5

APPLICATION AREA		BRB 4 KIT 1	BRB 4 KIT 3	BRB 4 KIT 5
Clamping system		NC	NC	NC
Code	[230 V]	790 186 011	790 186 013	790 186 015
Pipe ID/clamping area Ø	[mm]	19.1 - 47.0	35.0 - 108.0	19.1 - 108.0
	[inch]	0.752 - 1.850	1.378 - 4.252	0.752 - 4.252
Tool holder Ø	[mm]	68.0/19.0	120.0/27.0	68.0/19.0 68.0/27.0 120.0/27.0
	[inch]	2.677/0.748	4.724/1.063	2.677/0.748 2.677/1.063 4.724/1.063
Mast Ø	[mm]	19.05	34.5	19.05 34.5
	[inch]	0.750	1.358	0.750 1.358
Pipe OD	[mm]	23.0 - 68.0	38.5 - 114.3	23.0 - 114.3
	[inch]	0.906 - 2.677	1.516 - 4.50	0.906 - 4.50
Wall thickness* min. - max.	[mm]	2.0 - 15.0	2.0 - 15.0	2.0 - 15.0
	[inch]	0,079 - 0,590	0,079 - 0,590	0,079 - 0,590
SCOPE OF DELIVERY		BRB 4 KIT 1	BRB 4 KIT 3	BRB 4 KIT 5
Boiler pipe preparation machine	PCS.	1	1	1
Hard-sided transport case	PCS.	1	1	1
Tool holders (dimensions, see table above)	PCS.	1	1	3
Clamping wedge sets (dimensions, see table above)	Set	9	10 (8+2)	9 (9+8+2)
Mast (dimensions, see table above)	PCS.	1	1	2
Cooling cutting material KSS-TOP (Code 790 060 226)	PCS.	1	1	1
Tool key	Set	1	1	1
Operating instructions and spare part list	Set	1	1	1

* Depending on material and dimension. For BRB 4: Aluminum up to 15 mm/0.59" wall thickness. Special steel up to 8 mm/0.315" wall thickness. Steel up to 10 mm/0.39" wall thickness

Technical specifications are non-binding. They do not constitute any assurance of properties. We reserve the right to make changes.

Boiler pipe preparation machines

BRB 4

Properties, application area, technical specifications and delivery scope, see from page 53.

Tool holder, multifunctional tools have to be ordered separately, see from page 60.

ITEM	VERSION	CLAMPING SYSTEM	CODE	MACHINE WEIGHT KG	SHIPPING WEIGHT KG
BRB 4 EL, Kit 1	230 V, 50/60 Hz EU	NC	790 186 011	11.0	22.300
BRB 4 EL, Kit 3	230 V, 50/60 Hz EU	NC	790 186 013	11.7	23.900
BRB 4 EL, Kit 5	230 V, 50/60 Hz EU	NC	790 186 015	11.0 - 11.7	26.600

Suitable accessories:

- Tool holder WH, see page 60
- Multifunctional tools MFW, see page 61
- Combination possibilities of WHs and MFWs, see page 63
- Feed ratchet for BRB 4, see page 62
- Balancer spring, see page 62
- Cooling cutting material KSS-TOP, see page 62
- Folding workbench, see page 80

The different weld seam joint forms:

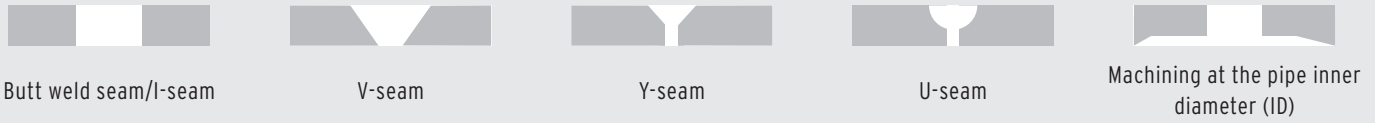

The designations of the tools of Orbitalum Tools:

Examples:

Multifunctional tool MFW for processing at pipe outer diameter (**MFW 30-V/I-4-R5**):

Multifunctional tool	Max. processable wall thickness in mm	Joint forms	Number of cutting edges	Joint radius in mm
MFW	30	V/I	4	R5

Multifunctional tool MFW for processing at pipe inner diameter (**MFW 10-ID-2-R0,8**):

Multifunctional tool	Max. length of the inside turning/bevel	For processing at inner diameter	Number of cutting edges	Joint radius in mm
MFW	10	ID	2	R0.8

Tool holder WH for beveling (**WH 30-V-30°**):

Tool holder	Max. processable wall thickness in mm	Joint form	Flank angle
WH	30	V	30°

Tool holder WH for facing (**WH 30-I-H27**):

Tool holder	Max. processable wall thickness in mm	Joint form	Holder height in mm
WH	30	I	H27

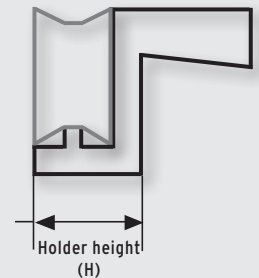

Tool holder WH for inside turning (**WH 10-ID-14°**):

Tool holder	Max. length of the inside turning/bevel	For processing at inner diameter	Discharge angle of the inside turning
WH	10	ID	14°

Do you need help with selecting the correct tool?

Then contact us via the form on page 52.

REB 6

Pipe end processing machine

The REB portable pipe end processing machines set standards in the weld seam preparation of metal pipes. Use these technical innovations to lower your tool and manufacturing costs and to increase your productivity during the manufacturing of precise and reproducible joint forms, both on the construction site as well as in preproduction.

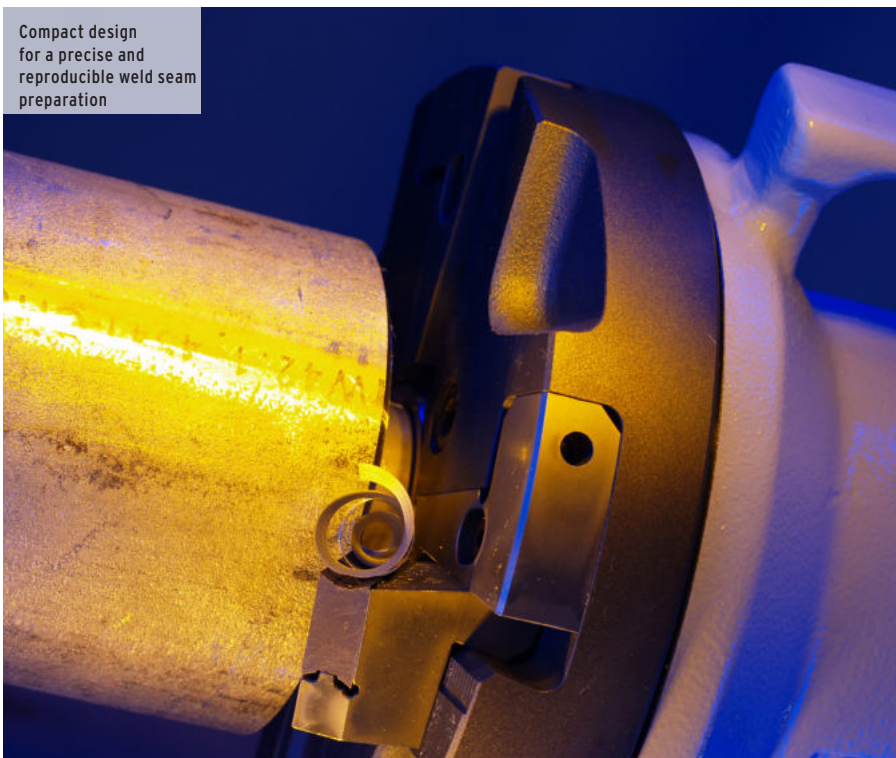

Compact design
for a precise and
reproducible weld seam
preparation

Compact design	✓
For a precise and reproducible weld seam preparation	✓
Quick tool change QTC® system	✓
Right-angled and burr-free	✓
Base plate with 4 or 2 cutting edges and high-performance coating	✓
Characteristic free standing housing	✓
Tools adaptable to all REB machines	✓
Power- and ergonomic-oriented drive system	✓
Thanks to the integrated handle it can also be used very mobile in relation to the pipe	✓

The powerful solution for pipe end processing
Manufacturing of highly precise and reproducible weld seam joint forms and pipe ends made of high-alloyed steel (special steel) as well as low-alloyed and unalloyed steel with the innovate tool system QTC®. Up to 4 tools can be used simultaneously.

The REB machines are available in the following drive versions:

- **Electric:** 230V, 50/60Hz
Machine and accessories are supplied in a robust transport case.

With the quick tool change (QTC®) patented by Orbitalum Tools the tool can be changed quickly and easily.

All multifunctional tools (MFW) have up to 4 cutting edges and a high-performance coating against wear. This way pipe ends made of unalloyed, low-alloyed and high-alloyed steel with chromium-nickel content can be machined particularly quickly and economically with high precision.



Quick tool change QTC® system



Quick setting of the pipe dimension



REB 6 E



Including cooling cutting lubricant KSS-TOP



Large selection of tool holders and multifunctional tools (optionally available)

APPLICATION AREA*	REB 6 ELECTRIC	
	[230 V]	790 093 002
Pipe ID	[mm]	49 - 159
	[inch]	1.93 - 6.26
Wall thickness	[mm]	3 - 22
	[inch]	0.12 - 0.87
Pipe OD	[mm]	56 - 168.3
	[inch]	2.20 - 6.61
Materials		
TECHNICAL SPECIFICATIONS		
Dimensions	[mm]	640 x 260 x 420
	[inch]	25.2 x 10.2 x 16.5
Power	[kW]	1.2
Speed	[min ⁻¹]	10 - 32
Vibration level (EN 28662, part 1)	[m/s ²]	< 2.5
Sound pressure level at the workplace (average speed control)	[dB (A)]	During idling: Approx. 75 Under load: Approx. 77
SCOPE OF DELIVERY		
Pipe end processing machine	PCS.	1
Transportation case	PCS.	1
Clamping chuck	PCS.	1
Clamping wedge sets with 3 clamping wedges	PCS.	5
Cooling cutting material KSS-TOP (Code 790 060 226)	Pump sprayer	1
Tool key	Set	1
Operating instructions and spare part list	Set	1



REB on workbench



Thanks to the integrated handle it can also be used very mobile in relation to the pipe

Technical specifications are non-binding. They do not constitute any assurance of properties. We reserve the right to make changes.

* Dimension extension with optional clamping wedge sets possible (special accessories)



REB 6 electrical

Pipe end processing machines

REB 6

Properties, application area, technical specifications and delivery scope, see from pPage 57.

Tool holder and multifunctional tools have to be ordered separately, see from pPage 60.

ITEM	VERSION	CODE	MACHINE WEIGHT KG	SHIPPING WEIGHT KG
REB 6	230 V, 50/60 Hz EU	790 093 002	35.000	55.000



REB 6 electrical

Suitable accessories:

- Tool holder WH, see pPage 60
- Multifunctional tools MFW, see pPage 61
- Combination possibilities of WHs and MFWs, see pPage 63
- Cooling cutting material KSS-TOP, see pagePage 62
- Tube elbow tensioner, see pPage 62
- Clamping wedge sets, see page page 62
- Folding workbench, see pPage 80

Accessories for BRB and REB machines

Tool holder WH

Incl. Torx screw. Combination possibilities of tool holders and multifunctional tools, see page 63.

ITEM	WELD	CAN BE USED WITH MACHINE	HEIGHT [MM]	HEIGHT [INCH]	CODE	KG
WH12-I	I	BRB 4	20	0.787	790 086 210	0.035
WH12-I / short	I	BRB 4	14	0.551	790 086 281	0.032
WH15-I	I	BRB 4 / REB	20	0.787	790 092 202	0.100
WH15-I	I	BRB 4 / REB	27	1.063	790 092 204	0.100
WH15-I**	I	BRB 4 / REB	16.5 - 23	0,650 - 0,906	790 093 410	0.247
WH30-I	I	REB	20	0.787	790 093 202	0.166
WH30-I	I	REB	27	1.063	790 093 204	0.235
WH12-V-30°	V/Y	BRB 4	-	-	790 086 214	0.040
WH12-V-30° / short	V	BRB 4	-	-	790 086 282	0.036
WH12-V-37.5°	V/Y	BRB 4	-	-	790 086 216	0.040
WH12-V-45°	V/Y	BRB 4	-	-	790 086 474	0.052
WH12-V-80°	V/Y	BRB 4 / REB	-	-	790 093 462	0.115
WH12-V-35°	V/Y	BRB 4	-	-	790 086 272	0.048
WH15-V-30°	V/Y	BRB 4 / REB	-	-	790 092 210	0.100
WH15-V-37.5°	V/Y	BRB 4 / REB	-	-	790 092 216	0.100
WH12-V-37.5° / short	V	BRB 4	-	-	790 086 283	0.035
WH15-V-45°	V/Y	BRB 4 / REB	-	-	790 092 218	0.144
WH15-V-60°	V/Y	BRB 4 / REB	-	-	790 092 212	0.100
WH30-V-15°	V/Y	REB	-	-	790 093 468	0.200
WH30-V-25°	V/Y	REB	-	-	790 093 476	0.209
WH30-V-30°	V/Y	REB	-	-	790 093 210	0.192
WH30-V-32.5°	V/Y	REB	-	-	790 093 424	0.234
WH30-V-37.5°	V/Y	REB	-	-	790 093 216	0.199
WH30-V-40°	V/Y	REB	-	-	790 093 510	0.237
WH30-V-45°	V/Y	REB	-	-	790 093 404	0.204
WH12-U-10°	U	BRB 4	-	-	790 086 208	0.044
WH12-U-15°	U	BRB 4 / REB	-	-	790 086 213	0.044
WH12-U-20°	U	BRB 4	-	-	790 086 224	0.047
WH12-U-20° / large clamping surface	U	BRB 4 / REB	-	-	790 086 476	0.091
WH12-U-25°	U	BRB 4	-	-	790 086 212	0.051
WH30-U-5°	U	REB	-	-	790 093 509	0.210
WH30-U-7°	U	BRB 4 / REB	-	-	790 093 408	0.206
WH30-U-10°	U	BRB 4 / REB	-	-	790 093 220	0.174
WH30-U-14°	U	REB	-	-	790 093 474	0.190
WH30-U-20°	U	BRB 4 / REB	-	-	790 093 218	0.184
WH30-U-25°	U	REB	-	-	790 093 478	0.165
WH5-ID-14°	ID	BRB 4 / REB	-	-	790 093 406	0.139
WH5-ID-45°***	ID	BRB 4 / REB	-	-	790 086 218	0.055
WH10-ID-5° / long	ID	BRB 4 / REB	-	-	790 093 400	0.152
WH10-ID-14°	ID	BRB 4 / REB	-	-	790 093 402	0.160
WH10-ID-14° / 30 mm deep	ID	BRB 4 / REB	-	-	790 093 466	0.265
WH12-ID-10° / from ID 50	ID	BRB 4 / REB	-	-	790 086 280	0.060
WH10-ID-30°	ID	BRB 4 / REB	-	-	790 093 493	0.100
WH10-ID-45°	ID	REB	-	-	790 093 494	0.107
WH10-ID-80°***	ID	BRB 4	-	-	790 086 275	0.075
WH10-AD-10°	OD	BRB 4	-	-	790 086 276	

* Special holder for squaring pipes in pipe sheets.

** Tool holder WH, adjustable for I-seam The scope of delivery includes: Adjustable tool holder, multifunctional tool MFW 15-V /I-4 (Code 790 093 037), Torx screws, adjustment plates.

*** Tool holder WH for cutting pipes from pipe sheets.



WH12-I



WH15-I**



WH15-V-30°



WH12-U-15°



WH5-ID-14°

Multifunctional tools MFW "Economy"

Uncoated turning plate tools with 2 or 4 cutting edges.

Can be used for pipes made of low-alloy and unalloyed steel, aluminum as well as cast materials.

ITEM	VERSION	FOR WALL THICKNESSES		CAN BE USED WITH WH/FOR JOINT FORM	CAN BE USED WITH	CODE	KG
		[MM]	[INCH]				
MFW15-V/I-4	Economy	2 - 15	0,079 - 0,591	V, Y, I	BRB 4 / REB	790 093 047	0.033
MFW30-V / I-4	Economy	2 - 30	0,079 - 1,181	V, Y, I	REB	790 093 043	0.055

Multifunctional tools MFW "High-Performance"

Turning plate tools with 2 or 4 cutting edges coated with a high-performance tool wear protective coating. Can be used for pipes made of high-alloyed steel (special steel), low-alloy and unalloyed steel, aluminum as well as cast materials.

ITEM	VERSION	FOR WALL THICKNESSES		CAN BE USED WITH WH/FOR JOINT FORM	CAN BE USED WITH	CODE	KG
		[MM]	[INCH]				
MFW5-U-2-R0.4	High-Performance	Max. 6	Max. 0.236	WH5-I and WH5-U-20° with radius 0.4 mm	BRB 2	790 085 030	0.002
MFW5-U-2-R2	High-Performance	max. 6	Max. 0.236	WH5-I and WH5-U-20° with radius 2 mm	BRB 2	790 085 032	0.002
MFW30-V / I-4	High-Performance	2 - 30	0,079 - 1,181	V, Y, I	REB	790 093 033	0.055
MFW30-U-4-R5	High-Performance	2 - 30	0,079 - 1,181	V, Y, I, U with radius 5 mm	REB	790 093 034	0.055
MFW30-U-4-R2	High-Performance	2 - 30	0.079 - 1.181	V, Y, I, U with radius 2 mm	REB	790 093 035	0.060
MFW30-U-4-R0.4	High-Performance	2 - 30	0.079 - 1.181	V, Y, I, U with radius 0.4 mm	REB	790 093 042	0.060
MFW4-I-2	High-Performance	Max. 4	Max. 0.157	WH4-I-2 (special bracket)	BRB 2	790 085 031	0.002
MFW15-V /I-4	High-Performance	2 - 15	0.079 - 0.591	V, Y, I	BRB 4 / REB	790 093 037	0.055
MFW12-V /I-2	High-Performance	2 - 12	0.079 - 0.472	V, Y, I, U with radius 1.2 mm	BRB 4	790 086 060	0.003
MFW12-U-2-R2	High-Performance	2 - 12	0.079 - 0.472	V, Y, I, U with radius 2 mm	BRB 4	790 086 064	0.003
MFW5-ID-2-R0.4 (14°)	High-Performance	-	-	WH5-ID-14° with radius 0.4 mm	BRB 4 / REB	790 093 039	0.003
MFW5-ID-2-R0.4 (45°)	High-Performance	-	-	WH5-ID-45° with radius 0.4 mm	BRB 4 / REB	790 086 061	0.002
MFW10-ID-2-R0.4 (80°)	High-Performance	-	-	WH10-ID-80° with radius 0.4 mm	BRB 4	790 086 062	0.002
MFW10-ID-2-R0.8 (14°)	High-Performance	-	-	WH10-ID-14° with radius 0.8 mm	REB	790 093 038	0.002
MFW10-ID-2-R3 (14°)	High-Performance	-	-	WH10-ID-14° with radius 3 mm	REB	790 093 041	0.004



Feed ratchet for BRB 4



Balancer spring



Cooling cutting material KSS-TOP



Tube elbow tensioner

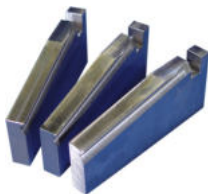

Clamping wedge sets optional

Feed ratchet for BRB 4

Specifically for the use in tight spaces, such as, for example when cutting finned pipes.

ITEM	CODE	KG
Feed ratchet for BRB 4	790 086 127	0.420

Balancer spring

For load-free hanging of BRB machines. Ideal for series processing! Using a balancer enables optimal processing results from relaxed and fatigue-free work with longer work duration, and at the same time ensures more safety for the user (machine is safeguarded from falling).

ITEM	CODE	KG
Balancer spring	832 030 002	3.800

Cooling cutting material KSS-TOP

The water-soluble, fully synthetic fluid increases the tool service lives of the turning plates. Has good corrosion protection characteristics. Was developed to drinking water requirements in accordance with the DVGW work sheet W521 (thread-cutting materials for drinking water installation) and corresponds in essential respects to these specifications. Is biologically readily degradable (OECD 302 B).

ITEM	VERSION	CODE	KG
Cooling cutting material KSS-TOP	Pump sprayer with 500 ml	790 060 226	0.630
Cooling cutting material KSS-TOP refill canister	Canister with 10l	790 060 227	11.000

Tube elbow tensioner

For processing of tube elbows with the REB 6 with an ID of 75 to 157 mm (2.953" - 6.181").

Scope of delivery:

- 1 hard-sided case
- 1 mast with clamping device for tube elbows
- 1 alignment tool
- 8 clamping inserts with 3 pins for the dimension range 75 - 157 mm (2.953" - 6.181")

ITEM	CODE	KG
Tube elbow tensioner for REB 6 complete	790 093 015	9.900

Clamping wedge sets optional

For dimension extension of the standard REB machines.

ITEM	CAN BE USED WITH	PIPE ID [MM]	PIPE ID [INCH]	CODE	KG
Clamping wedge sets	REB 6	155 - 166	6,102 - 6,535	790 093 295	1.300

PIPE BEVELING TECHNOLOGY

Combination possibilities of tool holders WH and multi-functional tool MFW for REB and BRB machines

Tools for weld seam preparation "I-seam"			
CODE	TOOL HOLDER	TORX SCREWS	FITTING MFWs
790 086 210	WH 12-I-H 20 mm	790 086 220	790 086 060 with R 1.2
790 086 281	WH 12-I / short	790 086 220	790 086 060 with R 1.2
790 092 202	WH 15-I-H 20 mm	790 093 226	790 093 037 with R 0
790 092 204	WH 15-I-H 27 mm	790 093 226	790 093 037 with R 0
790 093 202	WH 30-I-H 20 mm	790 093 226	790 093 033 with R 0
790 093 204	WH 30-I-H 27 mm	790 093 226	790 093 033 with R 0
790 093 410	WH 15-I-H 16.5-23 mm (adjustable)	790 093 226 / 790 093 425	790 093 037 with R 0
Tools for weld seam preparation "V-seam" and "Y-seam"			
CODE	TOOL HOLDER	TORX SCREWS	FITTING MFWs
790 086 214	WH 12-V-30°	790 086 220	790 086 060 with R 1.2
790 086 282	WH 12-V-30° / short	790 086 220	790 086 060 with R 1.2
790 086 272	WH 12-V-35°	790 086 220	790 086 060 with R 1.2
790 086 216	WH 12-V-37.5°	790 086 220	790 086 060 with R 1.2
790 086 283	WH 12-V-37.5° / short	790 086 220	790 086 060 with R 1.2
790 086 474	WH 12-V-45°	790 086 022	790 086 060 with R 1.2
790 093 462	WH 12-V-80°	790 086 220	790 086 060 with R 1.2
790 092 210	WH 15-V-30°	790 093 226	790 093 037 with R 0 / 790 093 047
790 092 216	WH 15-V-37.5°	790 093 226	790 093 037 with R 0 / 790 093 047
790 092 218	WH 15-V-45°	790 093 226	790 093 037 with R 0 / 790 093 047
790 092 212	WH 15-V-60°	790 093 226	790 093 037 with R 0 / 790 093 047
790 093 468	WH 30-V-15°	790 093 226	790 093 033 with R 0 / 790 093 043
790 093 476	WH 30-V/U-25°	790 093 226	790 093 033 with R 0 / 790 093 043
790 093 210	WH 30-V-30°	790 093 226	790 093 033 with R 0 / 790 093 043
790 093 424	WH 30-V-32.5°	790 093 226	790 093 033 with R 0 / 790 093 043
790 093 216	WH 30-V-37.5°	790 093 226	790 093 033 with R 0 / 790 093 043
790 093 404	WH 30-V-45°	790 093 226	790 093 033 with R 0 / 790 093 043
790 093 470	WH 30-V-50°	790 093 226	790 093 033 with R 0 / 790 093 043
790 093 472	WH 30-V-55°	790 093 226	790 093 033 with R 0 / 790 093 043
Tools for weld seam preparation "U-seam"			
CODE	TOOL HOLDER	TORX SCREWS	FITTING MFWs
790 086 208	WH 12-U-10°	790 086 220	790 086 060 with R 1.2 / 790 086 064 with R 2
790 086 213	WH 12-U-15°	790 086 220	790 086 060 with R 1.2 / 790 086 064 with R 2
790 086 224	WH 12-U-20°	790 086 220	790 086 060 with R 1.2 / 790 086 064 with R 2
790 086 476	WH 12-U-20° large clamping surface	790 086 220	790 086 060 with R 1.2 / 790 086 064 with R 2
790 086 212	WH 12-U-25°	790 086 220	790 086 060 with R 1.2 / 790 086 064 with R 2
790 093 408	WH 30-U-7°	790 093 226	790 093 034 with R 5 / 790 093 035 with R 2
790 093 220	WH 30-U-10°	790 093 226	790 093 034 with R 5 / 790 093 035 with R 2
790 093 474	WH 30-U-14°	790 093 226	790 093 034 with R 5 / 790 093 035 with R 2
790 093 468	WH 30-V/U-15°	790 093 226	790 093 034 with R 5 / 790 093 035 with R 2
790 093 218	WH 30-U-20°	790 093 226	790 093 034 with R 5 / 790 093 035 with R 2
790 093 478	WH 30-U-25°	790 093 226	790 093 034 with R 5 / 790 093 035 with R 2
Tools for "Beveling/inside turning"			
CODE	TOOL HOLDER	TORX SCREWS	FITTING MFWs
790 093 406	WH 5-ID-14°	790 093 224	790 093 039 with R 0.4
790 086 218	WH 5-ID-45°	790 093 224	790 086 061 with R 0.4
790 093 400	WH 10-ID-5° / long	790 093 225	790 093 038 with R 0.8 / 790 093 041 with R 3
790 093 402	WH 10-ID-14°	790 093 225	790 093 038 with R 0.8 / 790 093 041 with R 3
790 093 466	WH 10-ID-14° / 30 mm deep	790 093 225	790 093 038 with R 0.8 / 790 093 041 with R 3
790 086 296	WH 10-ID-60°	790 093 225	790 093 038 with R 0.8 / 790 093 041 with R 3
790 086 275	WH 10-ID-80°	790 086 220	790 086 062 with R 0.4
790 086 280	WH 12-ID-10° / from ID 50	790 086 217	790 086 060 with R 1.2
790 093 494	WH 10-ID-45°	790 086 220	790 093 040 with R 0.8
790 093 493	WH 10-ID-30°	790 086 220	790 093 040 with R 0.8
Tools for "outer processing"			
CODE	TOOL HOLDER	TORX SCREWS	FITTING MFWs
790 086 276	WH 10-AD-10°	790 086 220	790 086 062 with R 0.4

Areas of application of tool holders for U-seam

		BRB 4 Mast Ø 19 WZT Ø 68		BRB 4 Mast Ø 32 WZT Ø 68		BRB 4 Mast Ø 32 WZT Ø 120		REB 6 Mast Ø 40 WZT Ø 183	
Maximum inner diameter for 1mm lip strength									
Code	Designation	ID max. [mm]	ID min. [mm]	ID max. [mm]	ID min. [mm]	ID max. [mm]	ID min. [mm]	ID max. [mm]	ID min. [mm]
790 085 228	WH 5-U-20°	-	-	-	-	104	34	159	49
790 093 220	WH 30-U-10°	-	-	-	-	58	34	121	49
790 093 474	WH 30-U-14°	-	-	-	-	58	34	121	49
790 093 468	WH 30-V/U-15°	-	-	-	-	58	34	121	49
790 093 218	WH 30-U-20°	-	-	-	-	58	34	121	49
790 093 478	WH 30-U-25°	-	-	-	-	58	34	121	49
790 093 408	WH 30-U-7°	-	-	-	-	58	34	121	49
790 086 208	WH 12-U-10°	32	21	-	-	84	34	147	49
790 086 224	WH 12-U-20°	32	21	-	-	84	34	147	49
790 086 212	WH 12-U-25°	32	21	-	-	84	34	147	49

Areas of application of tool holders for pipe inner processing

Inside turning		BRB 4 Mast Ø 19 WZT Ø 68		BRB 4 Mast Ø 32 WZT Ø 68		BRB 4 Mast Ø 32 WZT Ø 120		REB 6 Mast Ø 40 WZT Ø 183	
Processable pipe inner diameter (0.5 mm safety distance to the mast)									
Code	Designation	ID max. [mm]	ID min. [mm]	ID max. [mm]	ID min. [mm]	ID max. [mm]	ID min. [mm]	ID max. [mm]	ID min. [mm]
790 093 400	WH 10-ID-5° / long	-	-	-	-	105	61	159	71
790 093 402	WH 10-ID-14°	-	-	-	-	105	61	159	71
790 093 406	WH 5-ID-14°	-	-	-	-	96	43	159	60
790 093 466	WH 10-ID-14° / 30 mm deep	-	-	-	-	105	61	159	78
790 086 218	WH 5-ID-45°	49	27	49	37	107	37	159	58
Areas of application of tool holders for pipe sheet processing									
790 086 275	WH 10-ID-80°	58	43	58	56	110	56	159	64

* For diameter 20 mm: Maximum chamfer width 4 - 5 mm

Abbreviations:
WH = Tool holder
WZT = Tool carrier/holder

Lip lengths for use of plane holders 790 092 202 / 790 093 202 or 790 086 210

Code	Designation (C)	MFW 12-V/1-2-R1.2 790 086 060	MFW 30-U-4-R2 790 093 035	MFW 30-U-4-R5 790 093 034
		Lip length (X1)		
790 093 218	WH 30-U-20°	-	1.4 mm	0 mm
790 093 220	WH 30-U-10°	-	2.5 mm	0.5 mm
790 093 408	WH 30-U-7°	-	3.8 mm	1.1 mm
790 093 474	WH 30-U-14°	-	2.3 mm	0 mm
790 093 478	WH 30-U-25°	-	1.1 mm	0 mm
790 086 208	WH 12-U-10°	1.5 mm	-	-
790 086 212	WH 12-U-25°	1.5 mm	-	-
790 086 224	WH 12-U-20°	1.5 mm	-	-

Lip lengths for use of plane holders 790 093 410 (adjustable)

Code	Designation (C)	MFW 12-V/1-2-R1.2 790 086 060	MFW 30-U-4-R2 790 093 035	MFW 30-U-4-R5 790 093 034
		Lip length (X1)		
790 093 408	WH 30-U-7°	-	1 - 7 mm	0 - 2.5 mm
790 093 220	WH 30-U-10°	-	0 - 6 mm	0 - 3 mm
790 093 474	WH 30-U-14°	-	0 - 6.5 mm	0 - 1 mm
790 093 218	WH 30-U-20°	-	0 - 5 mm	0 - 3.5 mm
790 093 478	WH 30-U-25°	-	0 - 5 mm	0 - 1 mm
790 086 208	WH 12-U-10°	0 - 5 mm	-	-
790 086 224	WH 12-U-20°	0 - 5 mm	-	-
790 086 212	WH 12-U-25°	0 - 5 mm	-	-

Abbreviations:

WH = Tool holder

WZT = Tool carrier/holder

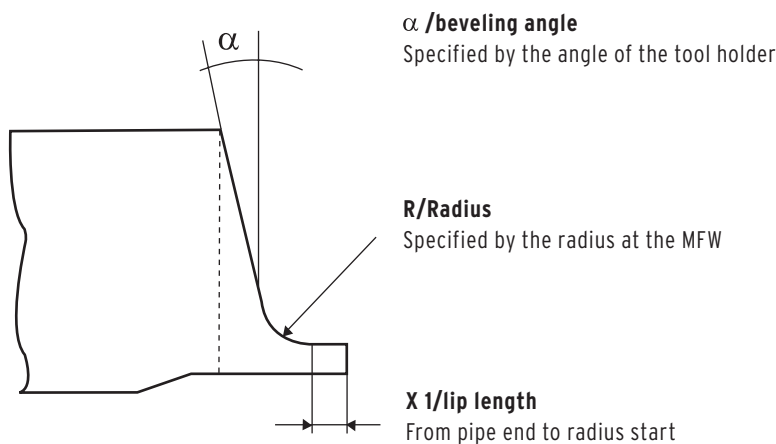

Electrode processing technology

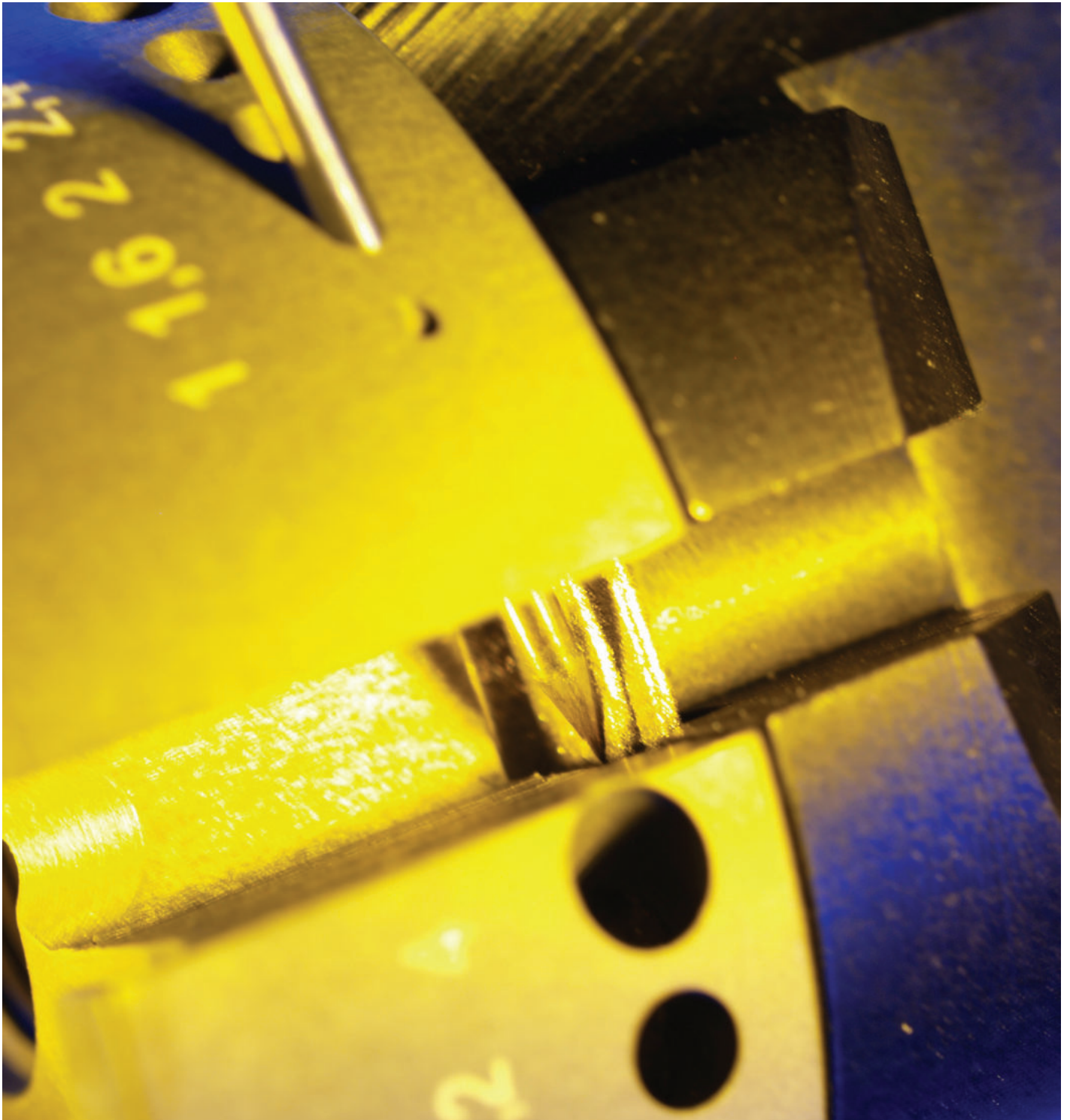

Orbital welding systems and accessories by Orbitalum Tools for high-purity process installations.



E.g. compact power source for mechanized TIG orbital welding with unique operating concept and a series of further technical features. In connection with an orbital weld head from ORBITALUM TOOLS the user receives an especially innovative as well as economical welding system.

You can find more information about these and other products for orbital welding in our "Orbital welding systems and accessories for high-purity process installations" catalog

ESG Plus, ESG Plus²

Electrode grinders

The optimum solution for precise and quick working of weld electrodes.

For working, grinding and cutting weld electrodes which are used in the TIG welding machines.



High angular precision through preset grinding angle for all electrodes

High angular precision through preset grinding angle for all electrodes	✓
Light and rapid processing	✓
Optimum preparation for orbital or manual welding	✓
Grinding in the longitudinal direction for optimal arc ignition and high arc stability	✓
Guarantees a higher service life and ignition ease of the tungsten electrode	✓
Specially for small batch production directly on the building site	✓
Compact version, optimal resistance and perfect repeatability	✓
Functional design	✓
Precise cylindrical grinding	✓

The powerful hand-held electrode grinding units for grinding, squaring and cutting.

One unit - complete electrode machining:

- Grinding electrodes:
 - 4 different angles
 - 6 different electrode diameters
- Squaring an electrode tip
- Cutting electrodes

The devices are equipped with a high-quality, powerful drive in 230 or 110 Volt design. Machine and accessories are supplied in a robust transport case.

ADDITIONAL ADVANTAGES:

- Device for easy cutting of the electrodes (optional)
- External vacuum cleaners can be adapted easily
- Short machining times through the high grinding capacity
- Reduced work required without setup time

ADDITIONAL CHARACTERISTICS ESG PLUS²:

- Portable electrode grinders with 2 different grinding wheels. This way the electrode can be pre-sanded with the rough diamond grinding wheel without any effort and sharpened with the fine diamond grinding wheel.

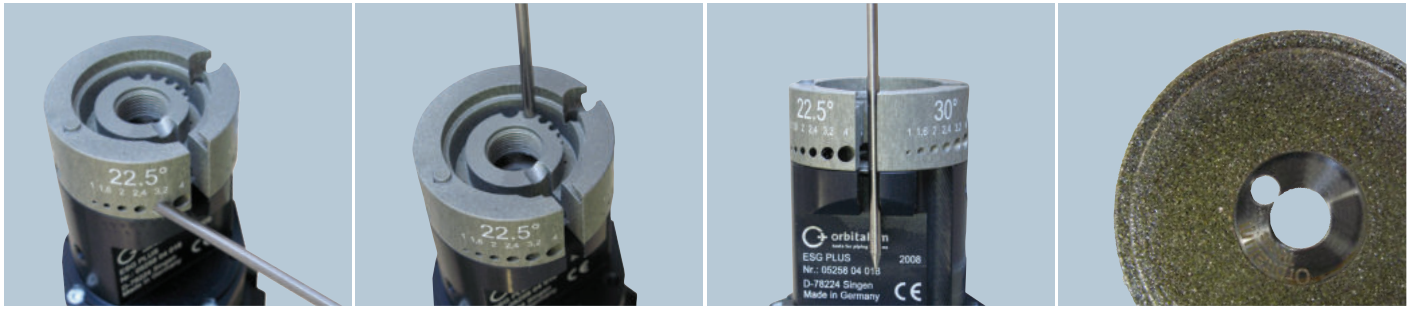

Grinding electrodes: - 4 different angles, 6 different electrode diameters

Squaring an electrode tip

Cutting electrodes

Interchangeable, diamond grinding wheels coated on both sides for an optimum operational performance



SCOPE OF DELIVERY/AREA OF APPLICATION		ESG PLUS	ESG PLUS ²
Code	[230 V]	790 052 485 (15°/18°/22.5°/30°) 790 052 545 (15°/30°/45°/60°)	790 052 585 (15°/18°/22.5°/30°) 790 052 546 (15°/30°/45°/60°)
	[110 V]	790 052 486 (15°/18°/22.5°/30°) 790 052 645 (15°/30°/45°/60°)	790 052 586 (15°/18°/22.5°/30°) 790 052 646 (15°/30°/45°/60°)
	Electrode grinder	PCS. 1	1
	Transport case	PCS. 1	1
Weld head for electrode Ø 1.0 - 1.6 - 2.0 - 2.4 - 3.2 - 4.0 mm (0.04" - 1/16" - 0.08" - 3/32" - 1/8" - 5/32") Grinding angle: 15° - 18° - 22.5° - 30° or 15° - 30° - 45° - 60°	PCS. 1	2	
Diamond grinding wheel fine (790 052 487)	PCS. -	1	
Diamond grinding wheel medium (790 052 488)	PCS. 1	-	
Diamond grinding wheel rough (790 052 550)	PCS. -	1	
Table mount	PCS. -	-	
Tool to change the grinding wheel	PCS. 1	1	
Operating instructions and spare part list	Set 1	1	
TECHNICAL SPECIFICATIONS		ESG PLUS	ESG PLUS ²
Dimensions (with drive)	[mm]	Ø 65 x 350	Ø 65 x 350
	[inch]	Ø 2.56 x 13.78	Ø 2.56 x 13.78
Power	[W]	500	500
Duty cycle	[%]	100	100
Speed (idle speed)	[rpm]	30.000	30.000
Power cable (length)	[m]	3	3
	[inch]	118.1	118.1
Vibration level (EN 28662, part 1)	[m/s ²]	< 2.5	< 2.5
Noise pressure level at the workplace (during idling), approx.	[dB (A)]	83	83

Technical specifications are non-binding. They do not constitute any assurance of properties. We reserve the right to make changes.

ESG electrode grinders

ESG Plus, ESG Plus²

Properties, application area, technical specifications and delivery scope, see from page 69.

ITEM	VERSION	GRINDING ANGLE [°]	CODE	MACHINE WEIGHT KG	SHIPPING WEIGHT KG
ESG Plus	230 V, 50/60 Hz EU	15/18/22.5/30	790 052 485	1.430	3.560
ESG Plus	110 V, 50/60 Hz EU/US	15/18/22.5/30	790 052 486	1.430	3.560
ESG Plus	230 V, 50/60 Hz EU	15/30/45/60	790 052 545	1.430	3.560
ESG Plus	110 V, 50/60 Hz EU/US	15/30/45/60	790 052 645	1.430	3.560
ESG Plus ²	230 V, 50/60 Hz EU	15/18/22.5/30	790 052 585	1.520	3.825
ESG Plus ²	110 V, 50/60 Hz EU/US	15/18/22.5/30	790 052 586	1.520	3.825
ESG Plus ²	230 V, 50/60 Hz EU	15/30/45/60	790 052 546	1.520	3.825
ESG Plus ²	110 V, 50/60 Hz EU/US	15/30/45/60	790 052 646	1.520	3.825



ESG Plus

ESG Plus²

Diamond grinding wheels

Interchangeable, diamond grinding wheels coated on both sides for an optimum operational performance.

For 1.0 and 1.6 mm electrodes we recommend the fine grinding wheel grains.
 For 2.0 mm and 2.4 electrodes an average grinding wheel grain is recommended and for 3.2 and 4.0 mm a rough grinding wheel grain.



Diamond grinding wheels

ITEM	CAN BE USED WITH	GRAIN	WHEEL Ø		S		CODE	KG
			[MM]	[INCH]	[MM]	[INCH]		
Diamond grinding wheel	ESG 4	Standard	32.00	1.290	1.2	0.047	790 052 460	0.005
Diamond grinding wheel	ESG Plus, ESG Plus ²	Fine	33.50	1.319	2.2	0.087	790 052 487	0.010
Diamond grinding wheel	ESG Plus, ESG Plus ²	Medium	33.50	1.319	2.2	0.087	790 052 488	0.011
Diamond grinding wheel	ESG Plus, ESG Plus ²	Rough	33.50	1.319	2.2	0.087	790 052 550	0.011

Cutting devices

For simple separating of the electrodes.

Can be used up to an electrode diameter of 2.4 mm (0.094").

ITEM	SETTING	CUTTING LENGTHS		CODE	KG
		[MM]	[INCH]		
Cutting device	fix	12.0	0.472	790 052 513	0.030
		13.0	0.512		
		15.0	0.591		
		17.0	0.669		



Cutting device



Electrode holder with collet



Spare collet



Wall, table vice mount

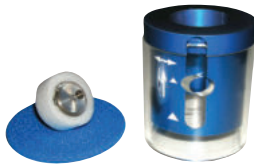

Dust protection



Double-decker kit

Electrode holder

For processing smaller electrodes.

The electrode holder is delivered including 1 flexible collet.

ITEM	SETTING	ELECTRODE Ø		CODE	KG
		[MM]	[INCH]		
Electrode holder with collet	continuous	1.0 - 3.2	0,039 - 0,126	790 052 457	0.023
Spare collet	continuous	1.0 - 3.2	0,039 - 0,126	790 052 481	0.002

Wall, table vice mount

For stationary use of the ESG Plus and ESG Plus².

Simple and rapid mounting to a wall, a table or a vice.

ITEM	CODE	KG
Wall, table vice mount	790 052 483	0.102

Dust protection

Easy to mount on the ESG grinding head

With integrated mounting for extraction systems with Ø 31mm (1.220").

To be used for electrodes containing thorium.

Country-specific regulations, standards and guidelines have to be observed.

ITEM	CODE	KG
Dust protection ESG Plus	790 052 496	0.170
Dust protection ESG Plus ²	790 052 596	0.220

Double-decker kit

Easy to mount for the ESG Plus. This mount allows simultaneous working with 2 different grinding wheels.

Including:

- 1 grinding head
- 1 diamond grinding wheel (rough)
- 1 cylinder-head screw with collar (M4x34)
- 1 shaft extension

ITEM	CAN BE USED WITH	GRINDING ANGLE [°]	CODE	KG
Double-decker kit	ESG Plus	15/18/22.5/30	790 052 490	0.160
Double-decker kit	ESG Plus	15/30/45/60	790 052 390	0.100

Thread-cutting and thread sealing technology

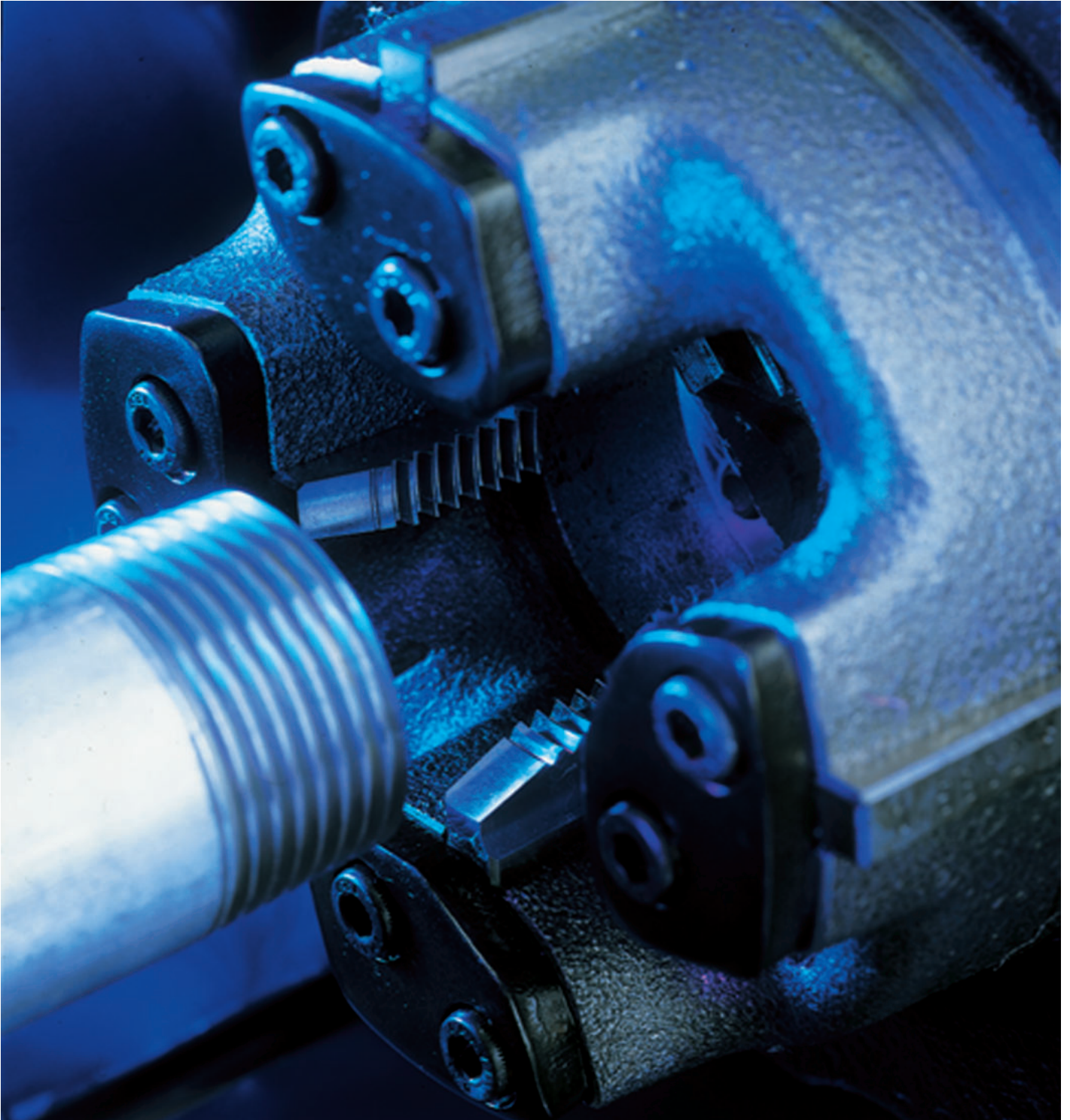



Replacement thread-cutting jaws for ASK



Nipple retainer

Accessories for thread-cutting technology

Replacement thread-cutting jaws for ASK cutting heads

For Whitworth pipe threads to DIN 2999.
Made of HSS. Clockwise direction

ITEM	VERSION	CODE	KG
Replacement thread-cutting jaws for ASK	R 3/8	790 003 503	0.100
Replacement thread-cutting jaws for ASK	R 1/2	790 003 504	0.145
Replacement thread-cutting jaws for ASK	R 3/4	790 003 505	0.130
Replacement thread-cutting jaws for ASK	R 1	790 003 506	0.170
Replacement thread-cutting jaws for ASK	R 1 1/4	790 003 507	0.145
Replacement thread-cutting jaws for ASK	R 1 1/2*	790 003 508	0.205
Replacement thread-cutting jaws for ASK	R 2*	790 003 509	0.260

* Not for TGA

Nipple retainer

With internal clamping. Self-clamping. For pipes according to DIN 2440.

ITEM	VERSION	CONNECTION THREAD	CODE	KG
Nipple retainer	DN 15	R 1/2	790 002 101	0.345
Nipple retainer	DN 20	R 3/4	790 002 102	0.566
Nipple retainer	DN 25	R 1	790 002 103	0.740
Nipple retainer	DN 32	R 1 1/4	790 002 104	1.120
Nipple retainer	DN 40*	R 1 1/2	790 002 105	1.420
Nipple retainer	DN 50*	R 2	790 002 106	2.120

* Not for TGA

Thread sealant

Flax dispenser "10-unit sales display package"

Package incl. 10 flax bobbins

Innovative and unique sales display package for representative display of flax bobbins on the sales counter.

For decades Orbitalum flax bobbins have stood for high-purity, finely-brushed flax with optimal sealing qualities and precise proportioning.

Additional advantages:

- Dispenser box including 10 flax bobbins (packaged individually)
- Parallel winding
- Optimal dispensing
- No waste
- Simple handling
- Suitable for dispenser



Flax dispenser "10-unit sales display package"

ITEM	VERSION	CODE	KG
Flax dispenser 10-unit sales display package	Including 10 flax bobbins	790 052 716	0.780



Seal dispenser



Seals

Seals

Seal dispenser

For gas and water installation. Approved by the DVGW in accordance with DIN 3535, Part 6.

With 225 asbestos-free seals. Including transparent labeled protective cover. Very robust, shock-proof and break-proof seal dispenser block made of elastic material that protects the seals against moisture, falling out or damage. The seals can be removed singly and are always at hand. Temperature stability up to 220 °C

ITEM	CODE	KG
Seal dispenser	790 052 721	0.682
Seal dispenser empty	790 052 722	0.335
Protective cover for seal dispenser	790 052 723	0.049

Seals

Asbestos-free.

Legend

R = Raccord (screw joint/ fittings)

RV = Radiator valve

H = Dutch seal

HK = Dutch seal small

HG = Dutch seal large

ITEM	VERSION	SIZE	NUMBER PER PACK-AGING	CODE	KG
Seals	R 1/4	10 x 6	100	790 052 726	0.001
Seals	R 3/8	14 x 10	100	790 052 727	0.002
Seals	R 3/8	15 x 8	100	790 052 728	0.002
Seals	R 3/8	15 x 10	100	790 052 729	0.002
Seals	R 1/2	18 x 10	100	790 052 730	0.002
Seals	R 1/2	18 x 11	100	790 052 731	0.002
Seals	R 1/2	18 x 12	100	790 052 732	0.002
Seals	R 3/4	23 x 17	100	790 052 733	0.002
Seals	R 3/4	24 x 15	100	790 052 734	0.002
Seals	R 1	30 x 22	100	790 052 735	0.003
Seals	R 1 1/4	37 x 29	100	790 052 736	0.002
Seals	R 1 1/4	39 x 32	100	790 052 737	0.002
Seals	R 1 1/2	44 x 37	100	790 052 738	0.003
Seals	R 2	56 x 48	50	790 052 739	0.002
Seals	Leather 3/4	23 x 16	100	790 052 740	0.002
Seals	RV 3/4	23 x 17	100	790 052 741	0.002
Seals	H 3/4	38 x 27	100	790 052 742	0.002
Seals	H 1	44 x 32	100	790 052 743	0.002
Seals	H 1 1/4	55 x 42	50	790 052 744	0.004
Seals	H 1 1/2	62 x 46	50	790 052 745	0.002
Seals	H 2	78 x 60	50	790 052 746	0.007
Seals	HK 3/8	24 x 17	100	790 052 747	0.002
Seals	HK 1/2	30 x 21	100	790 052 748	0.003
Seals	HG 3/8	27 x 19	100	790 052 749	0.002
Seals	HG 1/2	34 x 23	100	790 052 750	0.002

* Weight per seal

Copper pipe installation technology



Accessories for LAM 1500, LAM 1600

Rod electrodes

Minimum purchase amount: 6 pieces



Rod electrodes

ITEM	CODE	KG
Rod electrodes	790 057 026	0.020

Accessories for workshop and construction site





Folding workbench



Pipe deburring device

Folding workbench, pipe deburring device

Folding workbench

Can only be used for saws with field of application up to 4.5". Please use a pipe feeder (Code 790 068 051) or the mobile workstation (Code 790 068 071) as of 6" (see from page 23).

DIMENSIONS	FOLDING WORKBENCH
Size (LxWxH)	100 x 70 x 85 cm/39.37 x 27.56 x 33.46"

ITEM	CODE	KG
Folding workbench, surface loading 650 kg	790 052 030	30.000

Pipe deburring device

APPLICATION AREA	PIPE DEBURRING DEVICE
Pipe OD max.	54 mm/2.126"
Pipe ID max.	10 mm/0.394"

ITEM	CODE	KG
Pipe deburring device	790 052 052	0.455

ACCESSORIES FOR WORKSHOP AND CONSTRUCTION SITE



About Orbitalum

The best in the field of pipe cutting and beveling as well as orbital welding technology from a single source.

Since 50 years installation manufacturers have been relying on the standard formed by the market leader Orbitalum Tools in the industrial pipe end preparation.

Orbitalum Tools GmbH (Singen, Germany) and E.H. Wachs (Lincolnshire, Illinois, USA) together form the "ITW Orbital Cutting & Welding" group (short: ITW OCW), a business division of the US-American industrial group ITW.

Orbitalum Tools is a worldwide provider of complete solutions in industrial preproduction, installation and servicing of pipeline systems for everything from cutting pipes and preparing weld seams to orbital welding in process and plant engineering.

E.H. Wachs with its high-quality, nearly indestructible, portable and user-friendly pipe processing machines for cutting and beveling, has established itself in many industries: in the oil and gas industry, the chemical industry and in pipeline and ship construction - in the preproduction, maintenance, repair and dismantling of installations.

ITW (Illinois Tool Works), with headquarters in Glenview, Illinois/US is a US-listed "Fortune 200" company and a manufacturer operating worldwide for special production, special plants as well as provider for related services Organizationally ITW Orbital Cutting & Welding belongs to the ITW Welding Group which is among the world leading providers for welding units (e.g. MILLER ELECTRIC, HOBART BROTHERS).

With us as a partner you not only work with the industry leader for portable pipe processing machines and orbital welding systems, you also cooperate with ITW the global leader for demanding and future-oriented welding technologies.

The ITW Orbital Cutting & Welding Group stands for the best, most efficient technology in all aspects of orbital cutting and welding around the globe.

As ITW OCW we offer a nearly unique product availability, technical support worldwide as well as a sales network down to the local level. A partnership with ITW OCW includes:

- Recognized top technology, competent contact partner
- Quick, comprehensive delivery service
- Reliable product service
- Large inventories on a local level
- Comprehensive OEM spare parts and special production
- Strategically optimized positioned sales locations, service and rental centers
- Excellent technicians trained and certified in the factory
- Practical training courses - at our location or yours
- Certified company

ITW Orbital Cutting & Welding banks on excellent product solutions from Orbitalum and E.H. WACHS company. In combination with excellent service and advisory service, ITW OCW is the primary supplier for machines and tools for cutting, beveling and welding - all from a single source.

Environment and disposal instructions



Disposal of electric devices

(To Directive 2012/19/EU)

Electrical and electronic devices marked with the symbol above may not be disposed of with household garbage as per EU directive. By actively using the offered return and collection systems, you are doing your part to reuse and recycle used electrical and electronic devices. Used electric and electronic devices contain parts which must be handled specially as per EU directives. Separate collection and selective treatment are the basis for environmentally responsible disposal and protection of human health. We will properly dispose of devices and machines from us purchased from August 13th, 2005 if they are sent to us postage-paid. In the case of used devices which may represent a risk to human health or safety due to contamination during use, we have the option of refusing return. The user is responsible for disposing of used devices purchased before August 13th, 2005. For this purpose, please contact a professional disposal company in your area.

Important note for Germany: Our devices and machines may not be disposed of at communal dumps, as they are only used in the commercial sector.



Return of accumulators

Some of our devices are operated with accumulators. Accumulators and batteries that are marked with the above symbol may not be disposed of with household garbage as per EU Directive 2006/66/EC. In the case of accumulators containing hazardous materials the chemical sign for the heavy metal contained is specified below the refuse bin:

Cd = Cadmium
Hg = Quicksilver
Pb = Lead

Applies for Germany: The end consumer is obliged to return defective or used batteries to the distributor or to the returning facilities set up to this purpose.



The ITW ORBITAL CUTTING & WELDING Group offers global customers the best in the field of pipe cutting and beveling as well as orbital welding technology from a single source.



Certified Management System according to ISO 9001:2015



Approved Economic Operator with AEO certification

worldwide | sales + service

NORTH AMERICA

USA

E.H. Wachs
600 Knightsbridge Parkway
Lincolnshire, IL 60069
USA
Tel. +1 847 537 8800
Fax +1 847 520 1147
Toll Free 800 323 8185

NORTHEAST

Sales, Service & Rental Center
E.H. Wachs
1001 Lower Landing Road, Suite 208
Blackwood, New Jersey 08012
USA
Tel. +1 856 579 8747
Fax +1 856 579 8748

SOUTHEAST

Sales, Service & Rental Center
E.H. Wachs
171 Johns Road, Unit A
Greer, South Carolina 29650
USA
Tel. +1 864 655 4771
Fax +1 864 655 4772

NORTHWEST

Sales, Service & Rental Center
E.H. Wachs
2079 NE Aloclek Drive, Suite 1010
Hillsboro, Oregon 97124
USA
Tel. +1 503 941 9270
Fax +1 971 727 8936

GULF COAST

Sales, Service & Rental Center
E.H. Wachs
2220 South Philippe Avenue
Gonzales, LA 70737
USA
Tel. +1 225 644 7780
Fax +1 225 644 7785

HOUSTON SOUTH

Sales, Service & Rental Center
E.H. Wachs
3327 Daisy Street
Pasadena, Texas 77505
USA
Tel. +1 713 983 0784
Fax +1 713 983 0703

CANADA

Wachs Canada Ltd
Eastern Canada Sales, Service & Rental Center
1250 Journey's End Circle, Unit 5
Newmarket, Ontario L3Y 0B9
Canada
Tel. +1 905 830 8888
Fax +1 905 830 6050
Toll Free: 888 785 2000

Wachs Canada Ltd
Western Canada Sales, Service & Rental Center
5411 82 Ave NW
Edmonton, Alberta T6B 2J6
Canada
Tel. +1 780 469 6402
Fax +1 780 463 0654
Toll Free 800 661 4235

EUROPE

GERMANY

Orbitalum Tools GmbH
Josef-Schuetzler-Str. 17
78224 Singen
Germany
Tel. +49 (0) 77 31 - 792 0
Fax +49 (0) 77 31 - 792 500

UNITED KINGDOM

Wachs UK
UK Sales, Rental & Service Centre
Units 4 & 5 Navigation Park
Road One, Winsford Industrial Estate
Winsford, Cheshire CW7 3 RL
United Kingdom
Tel. +44 (0) 1606 861 423
Fax +44 (0) 1606 556 364

ASIA

CHINA

Orbitalum Tools
New Caohejing International
Business Centre
Room 2801-B, Building B
No 391 Gui Ping Road
Shanghai 200052
China
Mob. +86 (0) 186 2183 5518
Tel. +86 (0) 512 5016 7813
Fax +86 (0) 512 5016 7820

INDIA

ITW India Pvt. Ltd
Sr.no. 234/235 & 245
Plot no. 8, Gala #7
Indialand Global Industrial Park
Hinjawadi-Phase-1
Tal-Mulshi, Pune 411057
India
Tel. +91 (0) 20 32 00 25 39
Mob. +91 (0) 91 00 99 45 78

AFRICA & MIDDLE EAST

UNITED ARAB EMIRATES

Wachs Middle East & Africa Operations
PO Box 262543
Free Zone South FZS 5, AC06
Jebel Ali Free Zone (South-5), Dubai
United Arab Emirates
Tel. +971 4 88 65 211
Fax +971 4 88 65 212

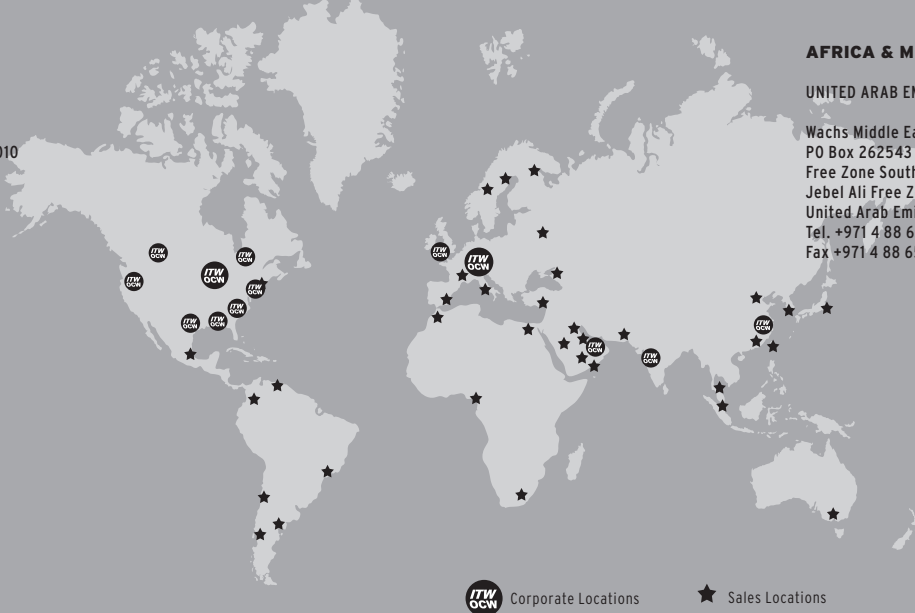

ITW OCW Corporate Locations

★ Sales Locations

© Orbitalum Tools GmbH | EN | 790 700 001 | Rev. 0421 | We reserve the right to make changes. Our general terms and conditions of business apply.



A brand of
ITW Orbital Cutting
& Welding